



DID1 ECU

-

reference manual

Baldur Gíslason

April 26, 2024

Contents

1	Introduction	4
1.0.1	Terminology	5
2	Wiring	8
2.1	Pin-outs and description	8
2.1.1	Pin numbering	8
2.1.2	Connector 1 pin-out	8
2.1.3	Connector 2 pin-out	8
2.1.4	Connector 3 pin-out	9
2.1.5	Connector 4 pin-out	11
2.1.6	Connector 5 pin-out	12
2.2	Wiring diagram	13
2.3	Wiring guidelines	14
2.3.1	What is required	14
2.3.2	Plug and play Mercedes Benz configuration	16
2.3.3	Grounding	17
2.3.4	12V feed	17
2.3.5	Analog sensor inputs	19
2.3.6	Injectors	19
2.3.7	Switching and PWM outputs	20
2.3.8	Glow plugs	20
2.3.9	MAP sensor	21
2.3.10	Rail pressure sensor	21
2.3.11	Temperature sensors	22
2.3.12	Crank and cam position sensors	22
2.3.13	Pedal position sensor	22
3	Software configuration	25
3.1	Getting started	25
3.2	Performing firmware upgrades	26
4	Extended features	28
4.1	Cruise control	28
4.2	OBD2 communications	29
4.2.1	Wiring	29
4.2.2	Standard OBD2 PIDs	29
4.2.3	Custom OBD2 PIDs	30
4.2.4	Transmitting data back	31

A	Error codes	32
B	W210 E320 CDI wiring diagram for reference (OM613 engine)	33
C	W220 S320 CDI wiring diagram for reference (OM613 engine)	43
D	W210 E220 or E270 CDI wiring diagram for reference (OM611 or OM612 engine)	53
E	W163 ML270 CDI wiring diagram for reference (OM612 engine)	64
F	Mercedes OM648 wiring	76
	F.1 W211 chassis side wiring	85
G	Mercedes OM646/OM647 wiring	89
H	Mercedes OM628 wiring	102
	H.1 Wiring of engine devices	102
	H.2 OEM chassis side wiring	104
	H.3 Factory diagrams W220 S400CDI	108
	H.4 Factory diagrams W163 ML400CDI	120
	H.5 Factory diagrams W463 G400CDI	132
I	Toyota 1KD-FTV wiring (early)	144
J	BMW M57 wiring (E46/E39)	153
	J.1 Component wiring	153
	J.2 Original ECU pinout	157
K	Ssangyong D27DT (OM665) wiring	160
	K.1 Component wiring	160
	K.2 Factory wiring diagrams	163
L	Mercedes Benz Sprinter 906 wiring	166

1 Introduction

DID1 is an engine control unit for common rail diesel engines with up to 8 cylinders equipped with solenoid injectors. It is also capable of driving unit injectors as well as some spill valve controlled injection pumps. The injector outputs have a programmable voltage boost to shorten the current rise time as well as a programmable current limit profile. Injectors can open multiple times per firing cycle but no two injectors can be open simultaneously.

Controllers sold after April 27th 2021 have a serial number from 200 and up and are a second generation design.

Notable hardware features:

8 injector outputs Software configurable boost voltage up to 100V.

Software configurable peak current up to 32A, high current phase up to 30A and hold current up to 21A. Controllers ordered for plug-and-play operation with Mercedes Benz OM61x engines have only 6 injector outputs. Previous generation controllers are without the high current phase in between peak and hold phases.

15 configurable low-side switch outputs 7 of which are PWM capable.

Previous generation has 11, with 7 PWM capable.

1 configurable high-side switch output As of serial number 300, there is one extra configurable output that switches +12V, added for easier compatibility with factory wiring on Toyotas which use +12V to trigger the glow heating relay.

Dedicated main relay output On first generation controller this was only for plug and play compatibility on Mercedes Benz applications. Later generations have a second ignition switch input and include the ability to delay shut down of the main relay for controlled engine shut off in applications that would otherwise have uncontrolled rail pressure while the engine spins down. Serial number 300 and up can also control a +12V switched main relay such as found on Toyotas.

14 0-5V analog inputs 2 of which are dedicated for accelerator pedal input. Of the rest, 2 have 3000 Ω pull-up resistors for thermistor bias, a further 2 can be configured between 57.6k Ω and 3000 Ω and the rest have 57.6k Ω pull-ups.

8 general purpose digital inputs Not counting crank/cam sensor inputs. All but inputs 2 and 8 are frequency capable. Input 8 is

capable of decoding RS232 serial data. All are 12V tolerant but with 5V pull-ups. Inputs 1 and 2 have software configurable pull-down resistors so they can register positive voltage input. Previous generation has 5 digital inputs.

1 K-type thermocouple input Measurable range 0 to 1350°C. Previous generation has a range of 0 to 950°C.

On board barometric pressure sensor

8 GB On board data logging memory Capable of recording data at up to 1000Hz on selected channels or every channel at up to 500Hz.

2 CAN 2.0B interfaces Capable of sending and receiving arbitrary data as well as serve OBD2 over CAN. Data rates configurable up to 1Mbps.

LIN bus interface For control of turbocharger actuators and other devices relying on LIN networking.

1 Analog output 0-5V mappable to perform any function, perfect to provide a throttle or engine torque signal to transmission controllers or other devices not CAN-enabled.

USB 2.0 for PC communication

1.0.1 Terminology

Some terminology and abbreviations found in this manual:

Analog input An input on the ECU that accepts a variable voltage ranging from 0 to 5 volts and the ECU will record this voltage.

BG Calibrator The software used to communicate with and configure the ECU.

CAN Controller Area Network. A communications interface that allows multiple computers to communicate by joining them all to a shared single pair of wires, capable of speeds up to 1 megabit per second but the most common configuration being 500 kilobits per second. In CAN terminology, termination refers to the connection of a 120 ohm resistor between the pair of wires. Two terminations must be present on a CAN network for correct operation, and these terminations can be located inside devices on the network or by the means of resistors connected directly. For best signal integrity the terminations should be located on each end of the network if the wiring is long.

Digital input An input on the ECU that accepts a variable voltage ranging from about negative 30 volts to positive 30 volts but the ECU will only register whether this voltage is below positive 1 volt (active low state 1) or above positive 2.5 volts (state 0). Voltages

in between 1.0 and 2.5 volts have an undefined state as hysteresis prevents changing states inside that range. Many of the digital inputs can record the frequency of voltage swings or interval between state changes as a means of measuring speed (vehicle speed, turbocharger speed, fluid flow rate, etc).

ECU Electronic Control Unit. Sometimes called Engine Control Unit.

Firmware The software that is installed inside the ECU.

Hall effect sensor A sensor that utilises the so called hall effect phenomenon to sense magnetic fields. Typical application crankshaft speed sensing, camshaft position sensing or vehicle speed sensing. Most typically has a permanent magnet built in to the sensor allowing it to sense metal teeth on rotating wheels but variants also exist that use moving permanent magnets as their targets. These sensors have circuitry inside them and have three terminals. One terminal connects to ground, another to a voltage supply (5V typically) and the third is typically an open collector (low-side switching) output that activates when metal is present at the tip of the sensor. Certain sensors also exist that utilise the hall effect phenomenon to measure displacement or angle of a magnet, such as solid state accelerator pedal position sensors.

LIN Local Interconnect Network. A low speed single wire communications interface typically used for small single purpose devices like actuators or switches. Maximum data rate 20 kilobits per second.

Low-side switch An ECU output that provides negative voltage (ground) to the circuit when activated, conducts no current otherwise. Any device connected to such an output such as a relay or a solenoid must have its other terminal connected to a positive voltage supply such as the vehicle's battery.

Main relay The relay that switches on power from the vehicle's battery to the ECU.

MAP Intake Manifold Absolute Pressure. The air pressure in the engine's intake manifold measured in absolute pressure units.

N/C No Connection. Means a wire or pin to which no connection should be made. Care should also be taken to isolate the wire so its bare metal can not make any unintentional connections.

Power ground A pin on the ECU meant to carry large currents. These pins must be connected to a low impedance ground, preferably directly to the battery negative terminal.

Pull down A resistor that pulls the voltage of a circuit close to ground level by sinking a small amount of current. When no other connection is made to the circuit the circuit will float at or close to ground level (0 volts). With a pull down, one end of the resistor is connected to ground while the other is connected to the circuit in question.

Pull up A resistor that lifts the voltage of a circuit above ground level by providing a small amount of current. When no other connection is made to the circuit the circuit will float at the same voltage as the pull up resistor connects to, otherwise the voltage will depend on the current sinking capability of the connected device. When the manual describes a pull up to 5 volts for example it means one end of the resistor is connected to a 5 volt supply and the other end connects to the circuit in question.

PWM Pulse Width Modulation. Where an output is pulsed on/off rapidly and the ratio between on and off time effectively modulates the current flowing in the circuit as well as the force enacted by the actuator it controls.

Sensor ground A pin on the ECU meant for grounding sensors to. These pins must not be connected to any other grounds in the vehicle. If significant conductance (10 ohms or below) can be measured from a sensor ground pin to the vehicle's chassis ground when the ECU is disconnected from the harness then that indicates a wiring error.

Thermistor A type of temperature sensor that exhibits a variable resistance as a function of temperature. To measure the resistance of the sensor the ECU must feed current through it by the means of a suitably strong pull up resistor and measure the resulting voltage with an analog input. Since the sensor is dependant on a current supply for value measurement it is not good practice to splice sensor wiring with another controller as this will interfere with the measurements if both controllers are feeding current to the circuit.

Thermo couple A type of temperature sensor formed by a junction of dissimilar metals that generates a small voltage when the junction is at different temperature than the other end of the wire connecting them. Typical use in this application is for exhaust gas temperature measurement. For the most accurate operation these must be connected by special wiring that maintains the same metal alloy from the temperature probe all the way back to the interface device.

Variable reluctance sensor (VR sensor) A sensor with 2 terminals consisting of a metal core, a coil of wire and a permanent magnet. Typically used to sense crankshaft speed, vehicle speed or camshaft position (see also hall effect sensor). Typically one wire is connected to a sensor ground and the other connects to an ECU input. Bringing a piece of metal close to the sensor's tip produces a voltage pulse and moving the metal piece away from the sensor's tip produces a voltage pulse of the opposite polarity. Thus the polarisation of the sensor's wiring matters and the ECU will pick up some signal regardless of the polarity but if its timing is of importance (crank trigger) the wiring polarity must be correct for correct operation. The amplitude of the signal is a function of the speed of the object moving near the tip of the sensor.

2 Wiring

2.1 Pin-outs and description

2.1.1 Pin numbering

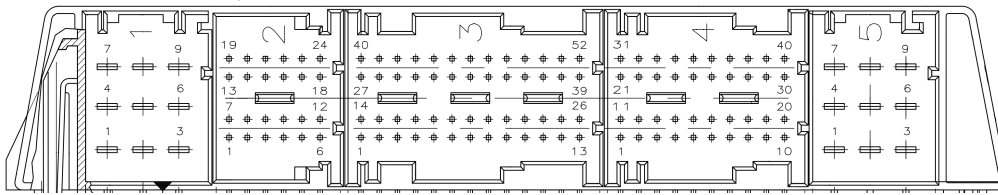

Figure 2.1: Connectors on the back of the controller and their pin numbering.

Below the function of each pin on the controller is listed. Any pins that have no internal connection are not listed.

2.1.2 Connector 1 pin-out

Pin	I/O	Function	Note
1	IN	12V supply for peripherals from main relay	10A max
4	IN	Power ground	
5	IN	Power ground	
6	IN	Power ground	
7	IN	12V supply from main relay	15A max
8	IN	12V supply from main relay	15A max

The ECU power must come from a relay that is controlled by the ECU. No variations from this are permitted except for testing that does not involve running an engine.

2.1.3 Connector 2 pin-out

Note that connector 2 is redundant, it has no functions that are not found elsewhere due to limited availability of the mating connector. The functions that are wired are only there for plug and play compatibility with Mercedes Benz OM61x plug and play applications.

Pin	I/O	Function	Note
11	IO	CAN 1 H	Internally terminated, also present on pin 3-1
12	IO	CAN 1 L	Internally terminated, also present on pin 3-2
13	IN	Ignition switch input	+12V switched to activate main relay. Also found on pin 3-31 on S/N 200 and up.

2.1.4 Connector 3 pin-out

Pin	I/O	Function	Note
1	IO	CAN 1 H	Internally terminated, also present on pin 2-11
2	IO	CAN 1 L	Internally terminated, also present on pin 2-12
3	IO	CAN 2 H	Internally terminated
4	IO	CAN 2 L	Internally terminated
5	OUT	5V reference output	200mA max. Typically accelerator pedal position sensor.
6	IN	Thermo couple +	K-type
7	IN	Thermo couple -	K-type
8	OUT	Sensor ground	Typically accelerator pedal position sensor.
9	IN	Analog input 1	Accelerator pedal secondary, 57.6k Ω pull up
10	IN	Analog input 0	Accelerator pedal primary, 100k Ω pull down
12	OUT	Output 9	Low-side switch, 5A max
14	IN	Analog input 8	57.6k Ω pull up
15	IN	Analog input 9	57.6k Ω or 3k Ω pull up (software selectable)
16	IN	Analog input 10	57.6k Ω or 3k Ω pull up (software selectable)
17	IN	Analog input 11	57.6k Ω pull up
18	OUT	5V reference output	200mA max
19	OUT	Sensor ground	
20	IN	Digital input 1	Active low, 12V tolerant, 10k pull up or 1k pull down software selectable
21	IN	Digital input 2	Active low, 12V tolerant, 10k pull up or 1k pull down software selectable. Not for frequency/speed input
22	IN	Digital input 3	Active low, 12V tolerant, 10k pull up
23	OUT	Sensor ground	Typically accelerator pedal position sensor.

Pin	I/O	Function	Note
24	IN	Digital input 5	Active low, 12V tolerant, 10k pull up
25	OUT	Output 11	Low side switch, 1A max, 4.7k pull up to 12V. Capable of bidirectional communication with glow plug relay.
26	IN	Digital input 4	Active low, 12V tolerant, 10k pull up
27	IN	Analog input 12	57.6k Ω pull up
28	IN	Analog input 13	57.6k Ω pull up
29	IN	Analog input 14	57.6k Ω pull up
30	OUT	12V accessory output	5A max
31	IN	Ignition switch input	+12V switched to activate main relay. Only on S/N 200 and up.
32	IN	Digital input 8	Active low, 12V tolerant, 10k pull up, only present on S/N 200 and up. Not for frequency/speed input but RS232 data capable (GPS NMEA or other purposes)
35	OUT	12V accessory output	5A max. Typically turbocharger control solenoid.
37	OUT	12V accessory output	5A max
40	OUT	5V reference output	200mA max
41	OUT	Sensor ground	
42	IO	LIN bus	Shared with pin 4-32. Not advisable to use both at same time.
43	OUT	Output 10	Low-side switch, 5A max
44	OUT	Main relay out positive	High-side switch, 1A max. S/N 300 and up only. ¹
45	OUT	Analog output	0-5V out
46	OUT	Main relay out negative	Low-side switch, 1A max
47	IN	Digital input 7	Active low, 12V tolerant, 10k pull up. S/N 200 and up only
48	OUT	Output 5	Low-side switch, 5A max. Typically turbocharger control solenoid.
49	OUT	Output 1	Low-side switch, 5A max, 1k Ω pull up to accessory 12V. Tachometer output capable.
50	OUT	Output 4	Low-side switch, 5A max, flyback diode to accessory 12V.
51	OUT	Output 7	Low-side switch, 5A max
52	OUT	Output 8	Low-side switch, 5A max

¹For main relay control, use one of the positive or negative outputs, the other leg of the relay coil must connect to ground or battery voltage respectively

2.1.5 Connector 4 pin-out

Pin	I/O	Function	Note
1	OUT	5V reference output	200mA max
2	OUT	Sensor ground	Typically cam position sensor
3	IN	Cam sync input	2.2k Ω pull-up, 12V tolerant. Hall effect or VR
4	OUT	Sensor ground	Typically rail pressure sensor.
6	IN	Analog input 6	MAP sensor input. 57.6k Ω pull-up
7	OUT	Sensor ground	Typically MAP sensor.
8	OUT	5V reference output	Typically MAP sensor. 200mA max
9	OUT	Injector output 8 logic level	S/N 500 and up only, or 10031 and up for branded variants.
10	OUT	Output 2	Low-side switch, 5A max
11	OUT	12V accessory output	5A max
12	OUT	5V reference output	200mA max
13	OUT	5V reference output	200mA max
14	IN	Analog input 4	Typically rail pressure sensor. 57.6k Ω pull-up
15	IN	Digital input 6	Active low, 12V tolerant, 10k pull up. Only S/N 200 and up. Oil pan sensor on Mercedes.
17	OUT	Sensor ground	Only on S/N 200 and up
18	OUT	5V reference output	200mA max
21	OUT	Output 3	Low-side switch, 5A max, flyback diode to accessory 12V. Typically rail pressure control solenoid.
22	OUT	12V accessory output	5A max
23	IN	Analog input 3	Typically charge air temperature sensor. 3k Ω pull-up
24	IN	Analog input 5	57.6k Ω pull-up.
25	OUT	12V accessory output	5A max
26	IN	Crank trigger input	2.2k Ω pull-up, 12V tolerant. Hall effect or VR
27	OUT	Sensor ground	Typically coolant/air temperature sensors.
29	OUT	Output 16	High-side switch, 1A max, S/N 300 and up only ²
30	OUT	Output 15	Low-side switch, 1A max, S/N 200 and up only

²Voltage must not get back-fed in to switched +12V outputs, meaning if the output is paralleled with an override switch, a diode must be used to prevent feeding current back in to the output

Pin	I/O	Function	Note
31	OUT	12V accessory output	5A max. Typically rail pressure control solenoid.
32	IO	Output 17	Low-side switch, 1A max, S/N 500 and up only, or 10031 and up for branded variants.
33	OUT	Output 6	Low-side switch, 5A max
34	OUT	Sensor ground	
36	IN	Analog input 2	Typically coolant temperature sensor. 3k Ω pull-up
37	OUT	Sensor ground	Typically crank trigger.
38	OUT	Output 12	Low-side switch, 1A max, S/N 200 and up only
39	OUT	Output 13	Low-side switch, 1A max, S/N 200 and up only
40	OUT	Output 14	Low-side switch, 1A max, S/N 200 and up only

2.1.6 Connector 5 pin-out

Pin	I/O	Function	Note
1	OUT	Injector 8 negative	Injector supply common on ECUs configured for OM611/OM612/OM613 plug and play
2	OUT	Injector 7 negative	Injector supply common on ECUs configured for OM611/OM612/OM613 plug and play
3	OUT	Injector 6 negative	
4	OUT	Injector positive common	
5	OUT	Injector 1 negative	
6	OUT	Injector 4 negative	
7	OUT	Injector 3 negative	
8	OUT	Injector 2 negative	
9	OUT	Injector 5 negative	

2.2 Wiring diagram

Work in progress.

2.3 Wiring guidelines

2.3.1 What is required

The minimum required wiring to run an engine consists of the following. All of the described sensors and actuators should be already present if you have a complete car with engine but some may be missing if you just have the engine by itself.

Main relay

Controls power to the ECU. Most OEM wiring harnesses have this already. The ECU should not receive its power from the ignition switch but rather there should be a relay that switches it on using a dedicated fused feed from the battery. See 12V feed section further down this chapter.

Crankshaft position sensor (crank trigger)

Supplies the ECU with information about the engine's rotational speed as well as the angle of the crankshaft. The recommended trigger wheel tooth count is 60 with two removed. If wheel diameter is limited, as few as 36 teeth may be used with one or two removed. Fewer than this can work but are not recommended as diesel engines are highly sensitive to the accuracy of the injection timing and can have high rates of crankshaft acceleration. Variable reluctance or hall effect sensors can be used. Some low output variable reluctance sensors require extra amplifier modules to be installed inside the controller. The crank position sensor has a dedicated input on connector 4 pin 26.

Camshaft position sensor (cam sync)

Supplies ECU with information on the phase of the cam shafts. Required during start up to match crank angle to the firing order on a 4 stroke engine. Variable reluctance or hall effect sensors can be used. Some low output variable reluctance sensors require extra amplifier modules to be installed inside the controller. The cam position sensor has a dedicated input on connector 4 pin 3.

Rail pressure sensor

If using a common rail engine, a rail pressure sensor is required for control over fuel rail pressure as well as computing the correct pulse width to deliver the commanded fuel quantity. The rail pressure sensor can connect to any analog input, the default is analog input 4, connector 4 pin 14.

Rail pressure control solenoid

Most common rail engines utilise some kind of solenoid for computer control of rail pressure. In some instances more than one solenoid. These are most typically located on the high pressure fuel pump but sometimes on the fuel rail itself. In the case of proportioning valves (most common) they should be connected to the high current PWM

outputs (outputs 3 or 4). In the case of synchronised suction valves they would connect to outputs 9 or 10.

Fuel injectors

This controller operates solenoid valve type injectors. These are the most common injectors found on common rail diesel engines. To distinguish solenoid valves from the less common but still common piezoelectric valves, set a multimeter to measure resistance in the range closest to 0 ohms. A solenoid will read less than 10 ohms continuously, a piezoelectric actuator will measure open circuit (no conductivity).

Accelerator pedal

Not required to start the engine but required to operate above idle speeds. The accelerator pedal wiring must be uncompromised with no connection to other devices than the ECU and preferably not shared with other sensors. The accelerator pedal should preferably be of dual potentiometer or solid state type with dual analog voltage outputs. Potentiometer + idle switch as commonly found on older diesel cars may also be used.

Components that are not as such required for start up but recommended for normal operation:

Intake Manifold Absolute Pressure sensor

Required for turbocharger control as well as limiting fuel during transient conditions. The MAP sensor has a dedicated input which is analog input 6 (connector 4 pin 6).

Coolant temperature sensor

The engine's characteristics are different when cold than when it is at operating temperature so best cold start and cold idle behaviour can not be achieved without coolant temperature data. Coolant temperature data is also required for automated control of glow plugs and cooling fans. There is not a dedicated input for the coolant temperature sensor but the default is analog input 2 (connector 4, pin 36).

Charge air temperature sensor

The density of the air is a function of air temperature, and while a diesel can tolerate large variations in oxygen to fuel ratio it is a good idea to have a charge air temperature sensor to compensate for air temperature and avoid overfuelling on a hot day with a heat soaked intercooler.

Glow plug relay

If the engine in question has glow plugs or other means of heat assisted cold starts, the ECU can control this. Two types of control are supported, a standard general purpose relay or a Mercedes Benz PWM glow controller as found on any electronically controlled Mercedes Benz diesel engine from 1996 until about 2006, with

4, 5, 6 or 8 cylinders. The same units have been found on some Volkswagens and possibly more cars that are not Mercedes Benz. PWM refers to the communications protocol these controllers use to communicate with the ECU, they do not employ pulse width modulation as a means of controlling glow plug temperature. A traditional relay can be controlled by any of the programmable outputs but a PWM glow controller should use output 11 (connector 3 pin 25) as that pin provides bidirectional communications allowing diagnostics of glow plug performance.

Turbocharger control

The DID1 ECU can control turbochargers, either with variable geometry or wastegates. Single, dual or even triple turbochargers, parallel or compound. In most instances this is done by PWM control and requires a solenoid valve to modulate the vacuum or pneumatic pressure on the actuator diaphragm. Programmable outputs 5 through 8 are typically used to perform this function. For electronic VGT actuators the method of control varies. Some use PWM control while others require CAN bus communication or even LIN bus communication. The DID1 ECU can support all of these but at the time of writing no LIN bus turbo actuator protocols have been coded.

Lift pump

This is an area where engines vary wildly, some have a mechanical low pressure lift pump integrated or attached to the high pressure pump. Others require an electric lift pump to feed the high pressure pump.

2.3.2 Plug and play Mercedes Benz configuration

The controller is designed to be plug and play for Mercedes Benz OM611, OM612, OM613 engines. However due to some differences between the wiring of different chassis containing these engines some modifications to the car's wiring may need to be done. The controller is designed to be fully plug and play for a W210 E320 CDI, other cars may need modifications. In the case of the W163 ML270 CDI, W210 E220 CDI, W210 E270 CDI or other cars with OM611 or OM612 engines the following wires need to be moved around:

OEM pin	DID1 pin	Colour	Note
3-22	4-7	green	MAP sensor ground
3-17	4-8	red	MAP sensor +5V
3-6	4-6	orange	MAP sensor signal
3-31	3-37	blue	M class only: Electric fan +12V switched (may be substituted for other +12V accessory pin)
3-45	3-52	orange	M class only: Electric fan PWM control from switching output 8
3-1	4-27	blue	Sensor ground for charge air temperature sensor. May substitute other sensor ground pin or splice existing wire.
3-12	4-23	orange	Charge air temperature sensor to analog input 3
3-40	N/C	blue	Remove wire to avoid interfering with on board diagnostics
3-28	N/C	orange	Remove wire to avoid interfering with on board diagnostics

2.3.3 Grounding

The controller should be connected to the battery negative terminal or another reliable grounding point by a no less than three 1.5 mm² (14-16 AWG) wires running in parallel. Length of ground wires should be kept as short as practical. An improper ground connection will cause electrical noise and possibly faults with controller operation.

Any sensors connected to the ECU must not be grounded elsewhere than to the ECU's sensor ground pins unless they are isolated circuits. Under no circumstance whatsoever may the controller's sensor ground pins be connected to any wiring that already has a connection to any other ground point in the vehicle at the risk of degraded sensor signal integrity and controller damage.

2.3.4 12V feed

The controller requires no less than two 1.5 mm² (14-16 AWG) running in parallel or a single 2.5 mm² (12 AWG) to the battery positive terminal through a fuse or circuit breaker and a relay. Power is to be fed into pins 7 and 8 of connector 1 and the circuit should be fused at 15-20A. Keep wiring as short as possible to limit electrical noise and voltage drop. A secondary supply for external accessories must also be wired for correct operation. This supply goes to pin 1 of connector 1 and should be fused at 10A if you are using the accessory power output pins on the ECU. If you are not using the accessory power output pins but rather the accessory power is distributed from elsewhere this fuse may be omitted but under no circumstance may the 12V connection to pin 1 be omitted. If your ECU is the first generation (serial number below 200) it does not have software control of main relay or ignition switch status detection.

This is fine as long as the ECU is being used on a fuel system that does not utilise a normally open suction control valve such as found on the Bosch CP3 high pressure pump and many others from other manufacturers. If this suction control valve is the only device controlling rail pressure then pressure will spike to the maximum the pump is capable of delivering if power is removed from the ECU before the engine has come to a stop. This is liable to cause damage to fuel system components if allowed to persist long term. The work around if using an older ECU on such a fuel system is to connect the ignition switch to a digital input for the ECU to detect and use a programmable output to keep the main relay energised until engine speed is zero.

ECUs with a serial number of 200 and up have software control of main relay built in and as of firmware version 1.8 the use of this feature is enforced as it has been discovered that if conditions are just wrong, damage can occur to ECU or fuel system components during engine shut down if not controlled. If you are using the ECU in a plug and play installation in a Mercedes Benz car, truck or van the main relay is already wired correctly from the factory, using pin 2/13 as an ignition switch input and 3/46 for main relay control output.

In any other application, you must ensure the correct wiring of the main relay or damage to the fuel system or ECU is possible. The correct wiring is as follows:

Ignition switch output Connects to pin 3/31 or if connector 2 is present, pin 2/13 can also be used. 3/31 is provided as an alternative on newer ECUs (S/N 200 and up) as the connector shells for connector 2 are not readily available.

Main relay common (terminal 30) Goes directly to battery positive, via a fuse.

Main relay contact (terminal 87) Goes to connector 1 pins 7, 8 and 1.

Main relay coil positive (terminal 86) Join to same battery positive connection as terminal 30.

Main relay coil negative (terminal 85) Connect to pin 3/46 on DID1.

If you are using the ECU in a motorsport application that requires an emergency shut off switch, the main relay for the ECU must still get its terminal 30 and terminal 86 power directly from the battery. The ignition switch input should come from the side that is isolated from the wiring harness. If you have other opinions please contact us to discuss your options to ensure reliable operation.

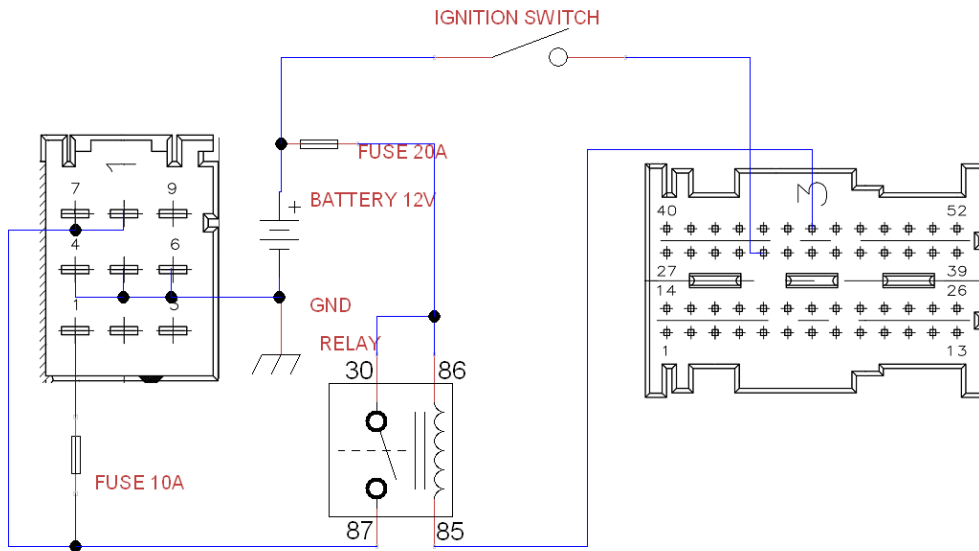

Figure 2.2: Correct power supply wiring for controllers with serial numbers 200 and up.

If you have an older ECU (S/N below 200) and need to use a fuel system whose pressure is controlled solely by a normally open suction control valve, contact us for advice on setting up main relay control with delayed shut off.

2.3.5 Analog sensor inputs

The analog sensor inputs have an input range from 0 to 5 volts. Under no circumstance may these inputs have voltages below 0 volts or above 5 volts supplied. Although the inputs are protected against damage in such situations the signal integrity of all analog inputs is compromised when any of the inputs are receiving voltage outside of the design range. For the greatest accuracy and repeatability, sensors that output an analog voltage should use the 5 volt reference outputs provided by the controller.

2.3.6 Injectors

If the ECU is ordered as a plug and play unit for Mercedes Benz OM61x engines there will be three pins providing positive voltage to the injectors. If the ECU is ordered in the 8 cylinder capable version it will have just one pin supplying positive voltage to the injectors and the other two pins become negative outputs for injectors 7 and 8.

For best performance the positive and negative wires for each injector should be twisted together all the way from the injector and the positive supply wires for the injectors should be joined close to the ECU. It is important to have very low resistance in the injector wiring so the wires should not be made longer than they need and they should use heavy gauge conductors. In any case no smaller than 1.5 mm^2 (14-16 AWG) as the resistance and inductance of these wires has an effect on the injectors ability to open quickly. An exception can be made for injectors that

require less than 10A peak current. Those can be wired with smaller gauge wiring.

Excessive resistance in the injector wiring increases losses in the system and thus overall load on injector power supply circuit.

2.3.7 Switching and PWM outputs

The ECU has eleven programmable outputs and while all low speed functions are applicable to every output, some PWM functions have dedicated outputs. This means that if those functions are used, they can only be assigned to the specified output. The outputs are low-side switches meaning the negative terminal of whatever device that is to be switched on is wired to the controller. The outputs are rated for 3A continuous current and 5A intermittent with the exception of output 11 so anything that draws more current must be wired through a relay. All outputs except 3 and 4 have a 30 volt flyback voltage clamp built in but may need an external flyback diode for high current high frequency PWM operation.

Pins 4-21 (Output 3) and 3-50 (Output 4) have flyback current diodes restricting flyback voltage to supply voltage, making them suitable for continuous PWM operation of loads greater than 1A current and greater than 100Hz. This also makes them unsuitable for switching accessories that are live when the supply to the ECU is switched off. Outputs 1 and 11 have pull-up resistors so their connection to devices that have constant power should be evaluated first, the exception to this is something like the Mercedes Benz smart glow plug relay which does not pull the data line high by itself even though the glow relay is powered directly off the battery.

2.3.8 Glow plugs

The ECU can control any standard glow plug relay as well as Mercedes single wire smart glow relay. The glow plugs are normally controlled by output 11, pin 3-25. Note that this output pin is not rated for current greater than about 1A so make sure the relay being used does not have a coil resistance of less than 12 ohms or use a different pin if this is not the case.

The Mercedes smart relay has a few connections. An M6 stud that connects directly to the battery positive terminal. A big connector with 6 pins that connects to the glow plugs. The same relay fits 4, 5 or 6 cylinder engines, 4 or 5 cylinder engines will just leave some pins unused.

Then there is a small connector with three pins. The pin terminals are labeled 31 for ground, DL for data link and TK which is not used. The ground wire is brown and the data link wire in the middle is usually white but sometimes uses other colours.

To control the Mercedes glow relay, the output used must be configured for `PWM glow control` in the Calibrator software. If using a modified Mercedes relay or using any general purpose relay, select the `Glow control` setting for the output.

Control of the Mercedes glow relay is only precise to the nearest second or so. If heating time of less than 1 second is specified the relay may not turn on at all.

The output used to control the Mercedes smart relay must have a 12V pull-up. The ECU has built in pull ups on outputs 1 and 11.

Output 11 has the ability to do bidirectional communication with the Mercedes Benz glow relay, if this output is used for communicating with the relay the ECU can detect and report the health of each individual glow plug. When a defective plug is detected the glow indicator will flash rapidly for a few seconds after glow plug preheating has ended and the Calibrator application will list glow plug errors in the controller error list found under the **Communications** menu.

2.3.9 MAP sensor

The ECU expects the intake manifold absolute pressure sensor to be connected to input 6 (connector 4 pin 6). Typically the MAP sensor will also take 5V power from pin 4-8 and sensor ground from pin 4-7.

If using a 4 bar GM style MAP sensor such as the one sold in the web shop, the table below describes its wiring:



MAP pin	Function	ECU pin
A	sensor ground	4/7
B	signal	4/6
C	+5V feed	4/8

If using a cylindrical MAP sensor such as the 5, 6 or 10 bar units sold in the web store, the wiring is as follows. Note that pins are labeled as if looking into the connector on the sensor itself.

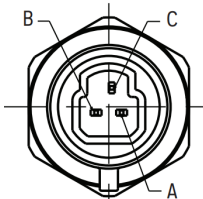

MAP pin	Function	ECU pin
A	sensor ground	4/7
B	+5V feed	4/8
C	signal	4/6

2.3.10 Rail pressure sensor

The fuel rail pressure sensor does not have a dedicated input but typical connection is analog input 4 (pin 4-14) with 5V supply taken from pin

4-13 and sensor ground at pin 4-4.

2.3.11 Temperature sensors

The temperature sensors do not have dedicated inputs but two analog inputs are provided that have a non-configurable 3 kilo ohm pull up resistor to them. Typical usage is to wire the coolant temperature sensor to analog input 2 (pin 4-36) and charge air temperature sensor to input 3 (pin 4-23) with sensor ground pins 4-27 and 4-34 used for return. Analog inputs 10 (pin 3-16) and 11 (pin 3-17) have a software controllable 3 kilo ohm pull up associated with them so these can be used to connect thermistors as well.

2.3.12 Crank and cam position sensors

For the crank and cam position sensors, both variable reluctance and hall effect type sensors are supported.

The crank position sensor has a dedicated input on pin 4-26 and a sensor ground on pin 4-37. If using a hall effect sensor it will need a 5V supply, this would typically come from pin 4-1 or 4-12.

The cam position sensor has a dedicated input on pin 4-3 and typically uses sensor ground pin 4-2 and +5V supply from pin 4-12.

2.3.13 Pedal position sensor

The ECU can utilise either single potentiometer with idle switch as found on most older electronically controlled diesels (including Mercedes OM60x) as well as dual potentiometer and solid state units.

It is highly recommended that the pedal wiring is of uncompromised integrity, with no branches to other devices, only connecting directly from the ECU to the accelerator pedal and not sharing these signals with any other devices in the car. If you require an accelerator position signal for another device such as a transmission computer, sharing the signal via CAN bus is the preferred option but if that is not possible the DID1 ECU provides an analog output that can be configured as a function of the accelerator pedal position.

PPS pin	Wire colour	Function	ECU pin
1	blue/green	primary 5V feed	3-5
2	brown	secondary ground	3-23
3	blue/grey	secondary 5V feed	3-5
4	violet/yellow	secondary signal	3-9
5	violet/green	primary signal	3-10
6	blue	primary ground	3-8

Figure 2.3: Wiring for Mercedes W210 OM60x diesel accelerator pedal position sensor. Round body, part number A0115428617

PPS pin	Wire colour	Function	ECU pin
1	blue/brown	5V feed	3-5
2		no connection	
3	brown/white	sensor ground	3-8
4	violet/yellow	secondary signal	3-9
5	violet/green	primary signal	3-10
6	brown/yellow	sensor ground	3-23

Figure 2.4: Wiring for Mercedes W210 petrol engine or common rail accelerator pedal position sensor, part number A0125423317 and others. Also found on other chassis.

PPS pin	Wire colour	Function	ECU pin
1	blue/brown	5V feed	3-5
2	violet/green	primary signal	3-10
3	brown/yellow	sensor ground	3-23
4	brown/white	sensor ground	3-8
5		no connection	
6	violet/yellow	secondary signal	3-9

Figure 2.5: Wiring for Mercedes W204 or W211 electronic pedal, part number A2043001204. This model has a connector with a single row of pins. This pin-out also applies to the pedal found on late model Sprints with common rail engines but wire colours are different on the Sprinter.

PPS pin	Wire colour	Function	ECU pin
1	blue/red	5V feed	3-5
2	brown/blue	sensor ground	3-23
3	blue/green	primary signal	3-10
4	brown/grey	sensor ground	3-8
5	grey/green	secondary signal	3-9

Figure 2.6: Wiring for Mercedes Sprinter T1N common rail pedal with 5 pin connector

PPS pin	Wire colour	Function	ECU pin
1	red/yellow	5V feed	3-5
2	yellow	primary signal	3-10
3	brown/yellow	sensor ground	3-23
4	brown/white	sensor ground	3-8
5	pink/violet	5V feed	3-18
6	white	secondary signal	3-9

Figure 2.7: Wiring for Mercedes Sprinter 906 with DPF pedal with 6 pin connector

PPS pin	Function	ECU pin
1	Kickdown switch	no connect
2	5V feed	3-18
3	sensor ground	3-23
4	primary signal	3-10
5	idle switch	3-9
6	sensor ground	3-8

Figure 2.8: Wiring for Volkswagen 1.9 PD accelerator pedal with unsealed 6 pin connector

3 Software configuration

Refer to [BG calibrator manual](#) for introduction to the PC application.

3.1 Getting started

It is advised to leave the injectors disconnected until correct operation of rail pressure control, crank trigger and accelerator pedal has been verified. The default configuration has the configurable outputs all disabled to avoid conflict with different cars after firmware upgrade. It is advised to check for firmware updates from the web site prior to first start, see the next section for information.

In any case, see if a base map for your engine is available from vendor before you start this process, it is a lot easier to start up with a base map that is already configured for your engine.

Steps to perform before starting engine:

1. Check accelerator pedal operation. Verify that `app` variable reads less than 0.0% when the pedal is released and that it reacts to movement of the pedal.
2. Check that rail pressure reads close to 0 when engine is stopped on a common rail application. Applications without a rail pressure sensor (not common rail) should set the minimum rail pressure to allow starting to 0.0 bar in the Starting section of the configuration.
3. Check that temperature sensors are operating, check variables `airtemp` and `coolanttemp` read reasonable values and perform calibration if they do not. These temperature sensors are not absolutely essential to operation of the engine so if they read incorrectly that may be put aside to be solved after first start up.
4. Check that the correct number of cylinders, firing order and injector output assignment is configured. Some common engines are found in the configuration presets (found in the Tools menu at the top of the screen in Calibrator).
5. Configure the programmable outputs, the presets (found in the Tools menu as configuration presets) are a good starting point.
6. Check that ignition switch and main relay are working, ECU powers on and off again when required. If ECU remains powered on it will

be difficult to stop the engine and this must be rectified before attempts are made to start the engine.

7. Verify correct operation of crank trigger. Run starter with injectors (connector 5) disconnected and verify that the Calibrator software displays engine speed as well as `syncstate` variable having a value of 7 after the starter has operated for a couple of seconds and that a steady but slightly varying engine speed is displayed while cranking.
8. Verify correct operation of rail pressure control. This can be done at the same time as the previous step. Run the starter with no injectors connected and see that the `railpressure` variable climbs after starting for a while and then finally settles on a stable value that is not greater than the `railtarget` variable. If there is air in the fuel system it may take a minute of cranking before rail pressure is observed and controllable. This step does not apply to applications other than common rail engines.
9. Now is a good idea to record an event log while cranking the engine and verify that the firing order and injection timing looks correct. This is done from the logging menu at the top of the screen of the Calibrator software. The ECU must be connected and another data log must not be in progress to enable this option.
10. If problems are observed, rectify them before continuing. Contact technical support for advice if anything is not clear.
11. Connect injectors and attempt to start engine.

3.2 Performing firmware upgrades

Whenever new features are introduced, new firmware becomes available for download at <https://controls.is/firmware/>. See the release notes if you are unsure of whether you should update or not.

To perform a firmware upgrade:

1. Download firmware package from web site
2. Unzip firmware package into a directory on your hard drive
3. Connect USB cable between ECU and PC.
4. Power on ECU, do not start engine.
5. If you do not have the configuration backed up, run BG Calibrator, read configuration from ECU and save to file. This step may be skipped if you are performing the upgrade on an ECU you haven't made any previous configuration changes to.
6. Run `upgrade.cmd` in directory where firmware files are located.
7. Wait until the upgrade application finishes, should be on the order of 10 seconds.

8. Power ECU off.
9. Do not power ECU back on until you are ready to upload configuration to it.

The ECU has been upgraded but now contains the default configuration. If you are proceeding with default configuration, simply open the default configuration file for the new firmware in BG calibrator and go on-line. Otherwise, if you wish to retain your previous configuration, which is generally recommended, perform the following steps:

1. Run the BG Calibrator software
2. Open your old configuration file
3. Select **File -> Convert configuration** from the menu bar.
4. Select the configuration included with the new firmware in the file dialog.
5. The configuration has now been converted to the new format, save it and the Calibrator software will restart.
6. Review the settings and verify that they make sense, see release notes for information about what settings may need revisiting.
7. Go on-line and power on the ECU. Do not start engine.
8. When prompted, select to use local settings, which will then be uploaded to the ECU.

After the configuration has been sent to the ECU and Calibrator application becomes responsive again, power the ECU off and then back on. Now you can start the engine.

4 Extended features

4.1 Cruise control

The cruise control requires three switches wired multiplexed into any analog input through different value resistors to ground or alternatively from a CAN bus source. Typically the resume/accel switch goes via 22k Ω resistor to ground, the set/decel switch goes via 10k Ω resistor to ground and a cancel switch directly to ground with no added series resistance. For best results these switches should ground to a sensor ground on the controller. For cancel input, one should at least have a brake pedal switch (or relay actuated from the brake light circuit) but may also have others wired in parallel such as a clutch switch and/or hand operated cancel switch. For automatic transmission applications, a vehicle speed input is necessary for cruise control operation. For manual transmission applications it is recommended that the vehicle speed input is wired for safety reasons (blocking cruise control from engaging below a certain vehicle speed) but not strictly necessary. If a visual indicator is desired when the cruise control is active, use one of the general purpose outputs and set a condition to turn on when `flag_cruise = 1`. For smooth operation of the cruise control, the road speed signal must be reasonably clean. If you are seeing variations of several km/h indicated when holding a steady speed you may be able to correct that using the VSS smoothing and pulse averaging functions.

The cruise control has a number of outputs that are of interest in the real time data feed.

cruisethrottle Throttle input from cruise control function.

cruiseP, cruiseI, cruiseD Cruise control PID loop output.

flag_cruise Indicator that cruise control is active.

cruiseswitch State indicator for cruise control switches.

Value	Description
0	No switch active
1	Stop switch active
2	Set/decel switch active
3	Resume/accel switch active

4.2 OBD2 communications

It is possible to perform OBD2 over CAN bus communications with the ECU on CAN bus 1. This enables the use of accessories that can display OBD2 data for instrumentation purposes (various OBD2 gauges, mobile phone applications and scan tools) as well as diagnostic trouble code readout. The protocol implemented is ISO15765-4 11 bit OBD over CAN. To enable this functionality, the following configuration parameters must be set:

CAN bus data mode 500kbit

CAN receiving enable Enabled

OBD2 service enable Enabled

For diagnostic trouble codes, see Appendix A

4.2.1 Wiring

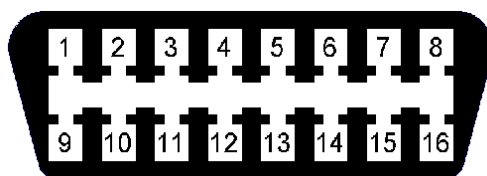

Figure 4.1: OBD2 female connector as seen from the end the scan tool plugs in to.

The OBD2 connector has four essential connections. Pin 6 (CAN-H) . Pin 14 (CAN-L) . Pins 4 and 5 connect to ground (any chassis ground will do) and pin 16 connects to +12V. The standard specifies that the +12V should be taken through a fuse directly from the battery but most OBD2 devices will also perform correctly if the 12V source is switched. For correct operation it may be necessary to have a 120 ohm termination resistor connected across the CAN wires if there is none connected to the CAN bus already.

4.2.2 Standard OBD2 PIDs

This is a list of the standard OBD2 PIDs the ECU reports:

PID	Description
0x05	Engine coolant temperature
0x0B	Manifold absolute pressure 0 - 2550mbar
0x0C	Engine speed
0x0D	Vehicle speed 0 - 255 km/h
0x0E	Main injection angle cylinder 1
0x0F	Charge air temperature
0x11	Effective accelerator pedal position
0x1F	Time since engine start
0x23	Fuel rail pressure
0x24	Lambda sensor 1
0x25	Lambda sensor 2
0x33	Barometer
0x42	Supply voltage
0x5A	Accelerator pedal actual position
0x5C	Engine oil temperature
0x5E	Fuel flow rate
0x78	Exhaust temperature sensors 1-4
0x79	Exhaust temperature sensors 5-8

4.2.3 Custom OBD2 PIDs

The ECU already implements nearly every standard OBD2 PID that is applicable to this application, but there are plenty of common sensors for which there is no documented standard OBD2 PID (for example, oil pressure) and also lots of examples of the ECU being used to monitor custom sensors. To facilitate this, custom OBD2 PIDs have been provided. The custom PIDs can be used to add PIDs and they can also override existing PIDs if desired. For a list of defined standard PIDs see https://en.wikipedia.org/wiki/OBD-II_PIDs

It is safe to define custom PIDs in the range of 197 up to 223 (0xC5 to 0xDF in hex) without conflicting with any predefined PIDs.

In the Torque app, the OBD2 command to retrieve these values is 01 succeeded by the PID in hex, so to get PID 197 for example it would be 01 C5 OBD2 specifies the data is always in big-endian format meaning the most significant byte comes first, so the following data types are provided, but for most scenarios it is recommended to stick to either u8 or u16be:

bit Single bit to indicate a status, 1 or 0. Treat the same as a u8 byte but with only 2 possible values. Example formula in Torque app: A

u8 Single unsigned byte ranging from 0 to 255. Example formula in Torque app: A

s8 Single signed byte ranging from -128 to 127. Example formula in Torque app: SIGNED(A)

u16be 2 byte 16 bit unsigned integer ranging from 0 to 65535. Example formula in Torque app: INT16(A:B)

s16be 2 byte 16 bit signed integer ranging from -32768 to 32767. Not simple to use in Torque app, use unsigned value and offset it using input/output scaling on ECU instead.

u32be 4 byte 32 bit unsigned integer ranging from 0 to 4294967295. Example formula in Torque app: INT32(A:B:C:D)

s32be 4 byte 32 bit signed integer ranging from -2147483648 to 2147483647. Not simple to use in Torque app, use unsigned value and offset it using input/output scaling on ECU instead.

4.2.4 Transmitting data back

The ECU provides a set of remotely manipulable bits that can be used to trigger things on or off, switching calibrations, etc. These bits can be manipulated by Calibrator scripts using the remote procedure call `remotebit` or using OBD2 commands.

To access the remote bits from OBD, use the `AA` command. The command takes 2 arguments. First argument is the bit number, from 00 to 07 and the second argument is the action to perform. The possible actions are:

- 00** Flip bit to 0 state.
- 01** Flip bit to 1 state.
- 02** Toggle bit between states.
- 03** Do nothing, just return current value.
- 04** Flip bit to 1 momentarily and then back to 0 about half a second later.

The `AA` command sends a reply on channel `EA` with two data bytes, the first data byte being the bit number that was accessed and the second data byte being the new state of that bit. To read the status of a bit using a custom PID in Torque, send the command `AA 00 03` where `00` is the bit you wish to read. The formula for the return data is simply `B`. To alter a bit from Torque create a push button widget that sends a raw OBD command, for example `AA 00 02` to toggle bit 0 between states each time you push the button.

Manipulating these bits from a Calibrator script can be done in a similar manner. Example:

```
[ "rpc", "remotebit", [ 0, 2 ] ] to toggle bit 0.
```

A Error codes

The error codes are stored on three bit masks, error0, error1 and error2, as described in the previous chapter. They can be read using the Calibrator application (**Communication -> View controller errors** in on-line mode, **Tools -> Decode error variables** in log view mode). It is also possible to read the errors using an OBD2 scan tool if OBD2 connector is wired and OBD2 communications are enabled in the configuration. OBD2 DTC codes take the form of **P3XZZ** where X is the error variable, 0 for error0 and so on and ZZ is the bit offset in that variable, starting with 00. Note that these codes do not correspond with any auto manufacturer's codes.

Errors that prohibit engine starting:

B W210 E320 CDI wiring diagram for reference (OM613 engine)

Document number: pe07.16-p-2000-99ed
Document title: Wiring diagram of common rail diesel injection (CDI)

Code:	Designation:	Coordinates:
B11/4	Coolant temperature sensor	11 L
B17	Intake air temperature sensor	10 L
B2/5	Hot film MAF sensor	20 L
B28	Pressure sensor	22 L
B4/6	Rail pressure sensor	9 L
B40	Oil sensor (oil level, temperature and quality)	14 L
B6/1	Camshaft Hall sensor	15 L
L5	Crankshaft position sensor	16 L
M55	Inlet port shutoff motor	12 L
N3/9	CDI control module	4 A
N3/9	CDI control module	12 A
N3/9	CDI control module	20 A
Y74	Pressure regulator valve	17 L
Y75	Electrical switch-off valve	18 L
Y76	Injectors (LH-SFI, HFM-SFI, PEC [LH, HFM, PMS])	3 L
Y76y1	Injector cylinder 1	1 L
Y76y2	Injector cylinder 2	4 L
Y76y3	Injector cylinder 3	2 L
Y76y4	Injector cylinder 4	5 L
Y76y5	Fuel injector cylinder 5	6 L
Y76y6	Fuel injector cylinder 6	8 L
Z15	Connector sleeve 7	13 H
Z6/8	Sensor ground connector sleeve	11 H
Z99/6	Common rail solenoid valve 1 connector sleeve	2 H
Z99/7	Common rail solenoid valve 2 connector sleeve	6 H

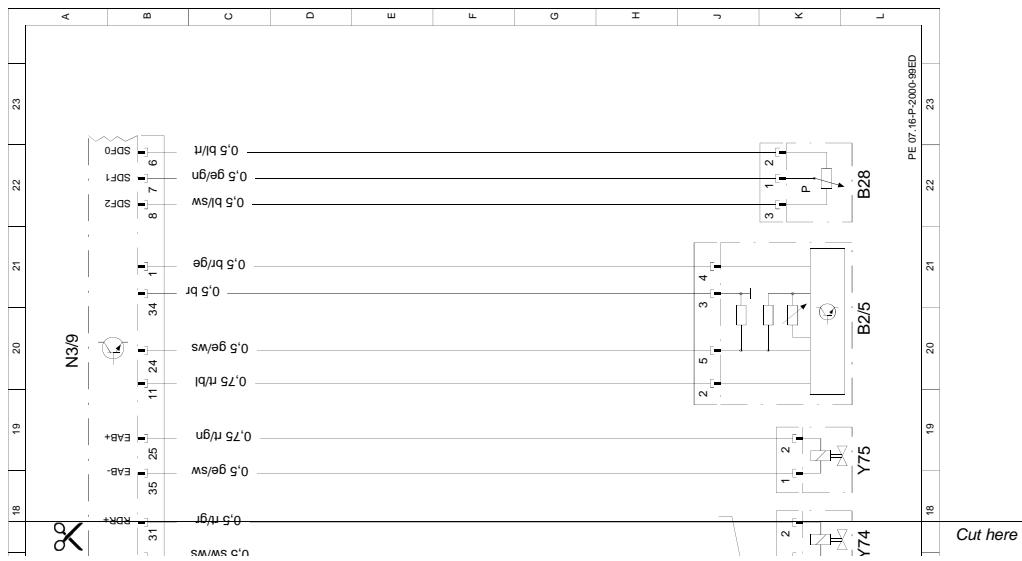

Wiring diagram of common rail diesel injection (CDI) / pe07.16-p-2000-99ed
ENGINE 613 in MODEL 210 except CODE (491) U.S. version Connectors 4 and 5 / Printed on: 06.01.2019 / Page 2/2

B. W210 E320 CDI wiring diagram for reference (OM613 engine)

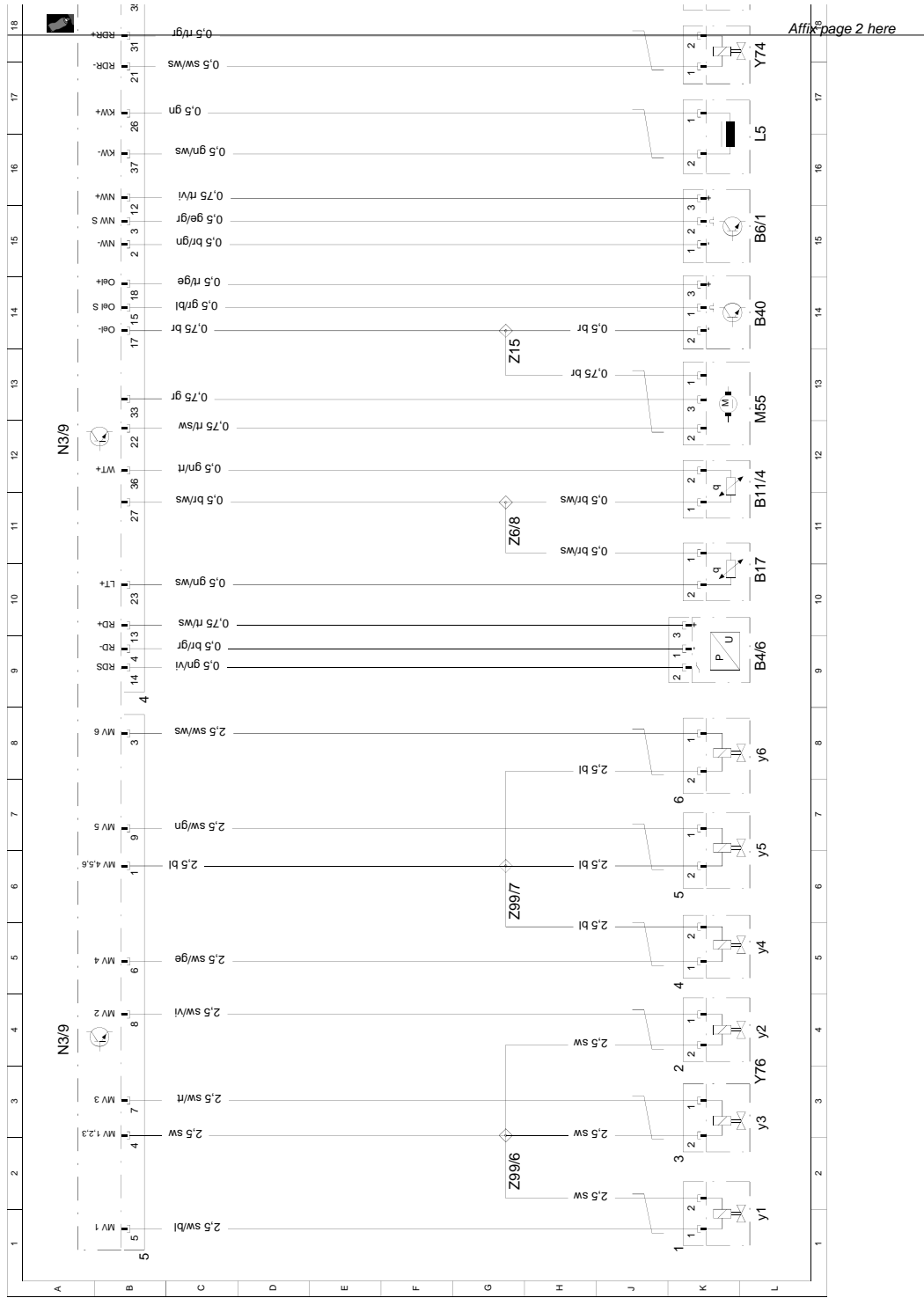

Wiring diagram of common rail diesel injection (CDI) / pe07.16-p-2000-99ed
ENGINE 613 in MODEL 210 except CODE (491) U.S. version Connectors 4 and 5 / Printed on: 06.01.2019 / Page 1/2

B. W210 E320 CDI wiring diagram for reference (OM613 engine)

Document number: pe07.16-p-2000-99ec
Document title: Wiring diagram of common rail diesel injection (CDI) control module

Code:	Designation:	Coordinates:
A1	Instrument cluster	56 L
A1	Instrument cluster	58 L
B37	Accelerator pedal sensor	37 L
F1	Fuse and relay box	49 L
F1f14	Fuse 14	49 K
G1	Battery	16 L
G2	Generator	53 L
K16	Heater booster relay	48 L
K40/4	Fuse and relay module (front passenger)	18 L
K40/4	Fuse and relay module (front passenger)	24 L
K40/4	Fuse and relay module (front passenger)	60 H
K40/4f1	Fuse, circuit 30z	19 L
K40/4f2	Fuse 2, diesel engine control module power supply	24 L
K40/4f3	Fuse 1, diesel engine control module power supply	23 L
K40/4f5	Fuse, ETC/ADS [EGS/ADS]	25 L
K40/4k1	Polarity protection relay	17 L
K40/4k2	Starter relay	20 L
K40/4k3	Diesel voltage supply relay	22 L
M1	Starter	32 L
M2/2	Control module box blower motor	30 L
N14/2	Preglow output	41 L
N15/5	Electronic selector lever module control module	14 L
N3/9	CDI control module	12 A
N3/9	CDI control module	20 A
N3/9	CDI control module	27 A
N3/9	CDI control module	36 A
N3/9	CDI control module	44 A
N3/9	CDI control module	52 A
N3/9	CDI control module	59 A
N33/2	Heater booster control module	45 L
N33/2x1	Heater booster control module connector	46 K
N73	DI control module	3 L
N73	DI control module	9 L
R39/1	Vent line heater element	33 L
R9	Glow plugs	40 E
S4/3	Heater booster switch	60 L
S40/4	CC with variable speed limiter switch	3 A
S40/4s1	Resume from memory	3 C
S40/4s2	Decelerate and set	3 C

B. W210 E320 CDI wiring diagram for reference (OM613 engine)

Document number: pe07.16-p-2000-99ec
Document title: Wiring diagram of common rail diesel injection (CDI) control module

Code:	Designation:	Coordinates:
S40/4s3	Accelerate and set	3 B
S40/4s4	Off	3 B
S40/4s5	Control contact	3 B
S40/4s6	Variable speed	4 C
U12	Valid for left-hand steering	27 D
U12	Valid for left-hand steering	29 D
U12	Valid for left-hand steering	31 D
U13	Valid for right-hand steering	26 D
U13	Valid for right-hand steering	28 D
U13	Valid for right-hand steering	29 H
U13	Valid for right-hand steering	30 D
W1	Main ground (behind instrument cluster)	9 H
W11/3	Ground (engine - left side)	33 H
W16/3	Ground (output ground-left wheel housing)	39 H
W16/4	Ground (output ground - right wheel housing)	21 E
W16/5	Electronics ground (left of component compartment)	26 E
W16/5	Electronics ground (left of component compartment)	28 E
W16/5	Electronics ground (left of component compartment)	30 E
W16/6	Electronics ground (right of component compartment)	26 E
W16/6	Electronics ground (right of component compartment)	28 E
W16/6	Electronics ground (right of component compartment)	30 E
X11/4	Data link connector	20 E
X11/4	Data link connector	26 E
X11/4	Data link connector	39 E
X12/3	Terminal block (circuit 30)	42 H
X12/3	Terminal block (circuit 30)	51 L
X12/3f1	Generator prefuse	43 G
X12/3f1	Generator prefuse	51 K
X22	Engine compartment and engine connector	53 E
X4	Terminal block (circuit 30, left footwell)	8 G
X4	Terminal block (circuit 30, left footwell)	31 H
X4	Terminal block (circuit 30, left footwell)	43 E
X4/2	Circuit 30 connector, heater booster, generator	50 E
X4/3	Circuit 30 connector, heater booster, battery	50 H
X63/6	CAN databus/15u connector	5 G
Y31/4	EGR [ARF]/pressure control flap vacuum transducer	34 L
Y31/5	Boost pressure control vacuum transducer	35 L
Z26	Circuit 61e connector sleeve	60 E
Z37/13	CAN engine bus (low) connector sleeve	6 H

Document number: pe07.16-p-2000-99ec
Document title: Wiring diagram of common rail diesel injection (CDI) control module

Code:	Designation:	Coordinates:
Z37/14	CAN engine bus (high) connector sleeve	5 H
Z37/2	CAN engine bus (low) connector sleeve	6 D
Z37/3	CAN engine bus (high) connector sleeve	5 D
Z7/24	Circuit 87 connector sleeve	24 E
Z7/30	Circuit 30 (unfused) connector sleeve	8 H
Z9	Connector sleeve 1	17 E

B. W210 E320 CDI wiring diagram for reference (OM613 engine)

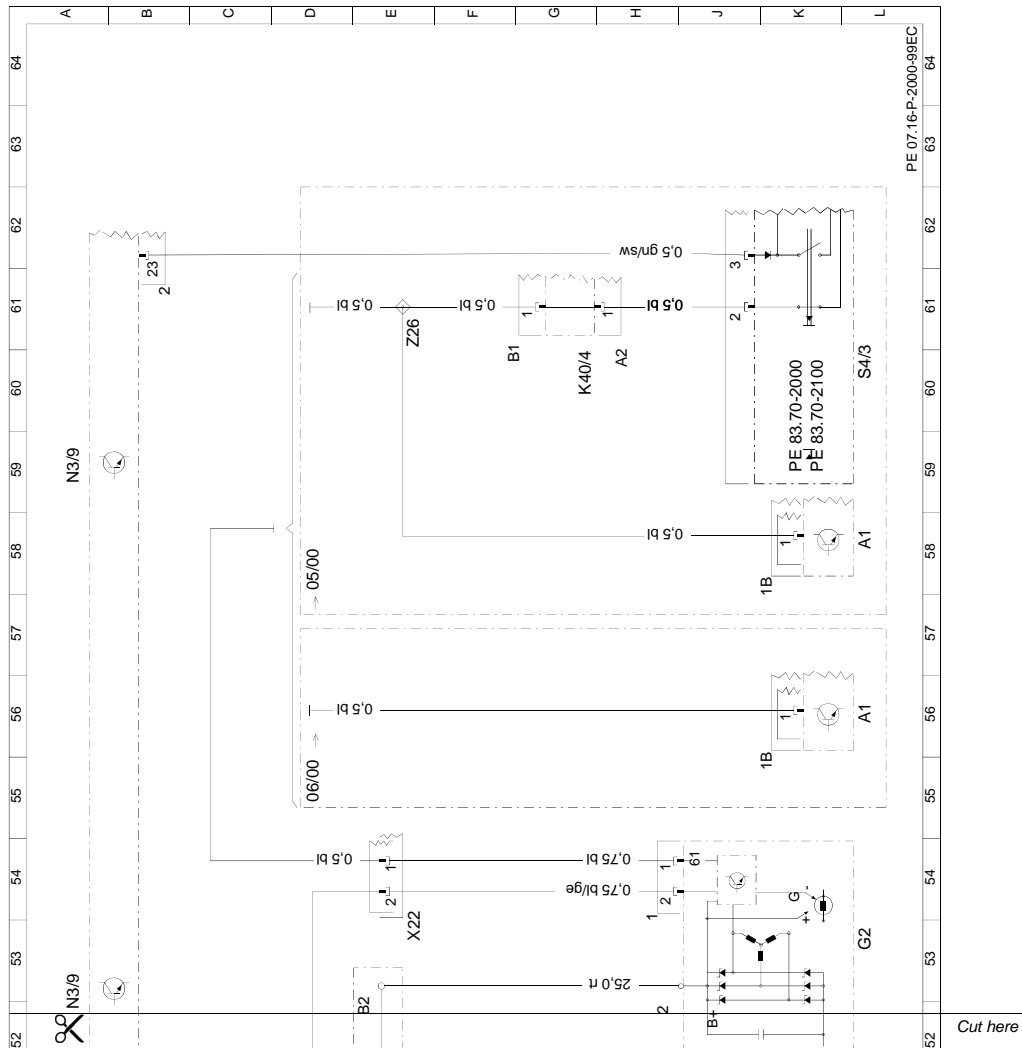

Wiring diagram of common rail diesel injection (CDI) control module / pe07.16-p-2000-99ec ENGINE 613 in MODEL 210 except CODE (491) U.S. version with CODE (440a) Cruise control plug 1 - 3, with electrical heater booster /

B. W210 E320 CDI wiring diagram for reference (OM613 engine)

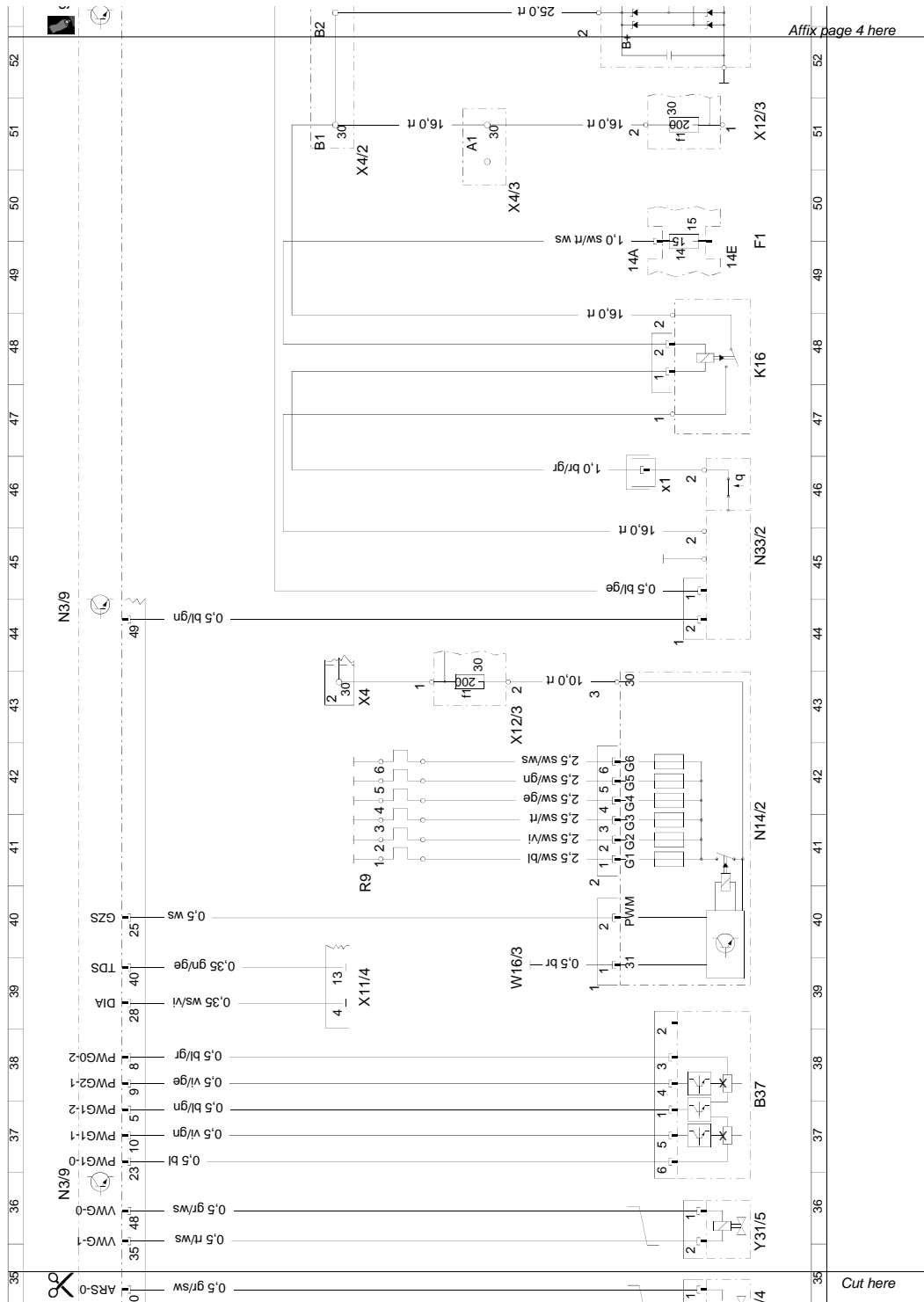

Affix page 4 here

Cut here

Wiring diagram of common rail diesel injection (CDI) control module / pe07.16-p-2000-99ec ENGINE 613 in MODEL 210 except CODE (491) U.S. version with CODE (440a) Cruise control plug 1 - 3, with electrical heater booster /

B. W210 E320 CDI wiring diagram for reference (OM613 engine)

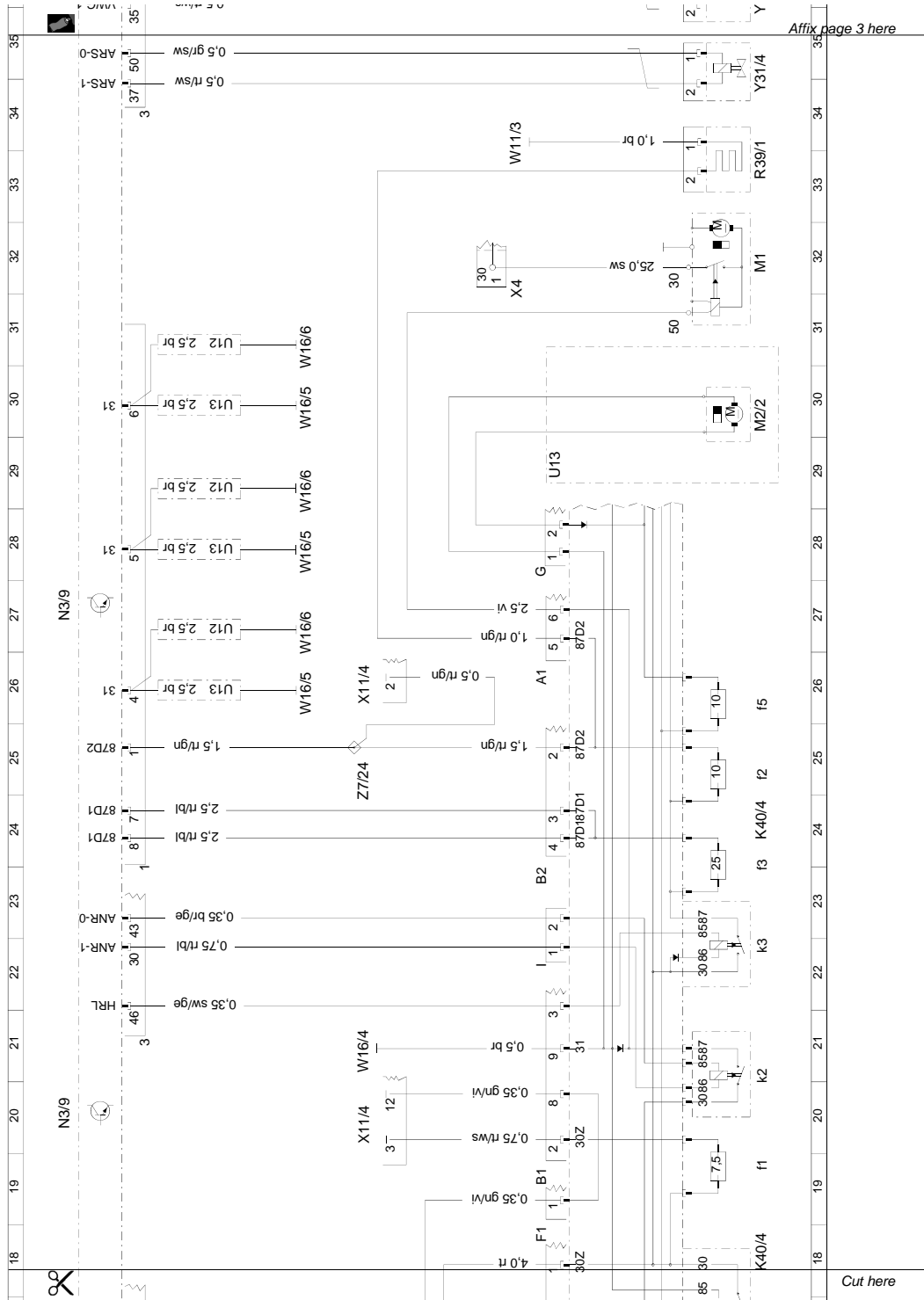

Wiring diagram of common rail diesel injection (CDI) control module / pe07.16-p-2000-99ec ENGINE 613 in MODEL 210 except CODE (491) U.S. version with CODE (440a) Cruise control plug 1 - 3, with electrical heater booster /

B. W210 E320 CDI wiring diagram for reference (OM613 engine)

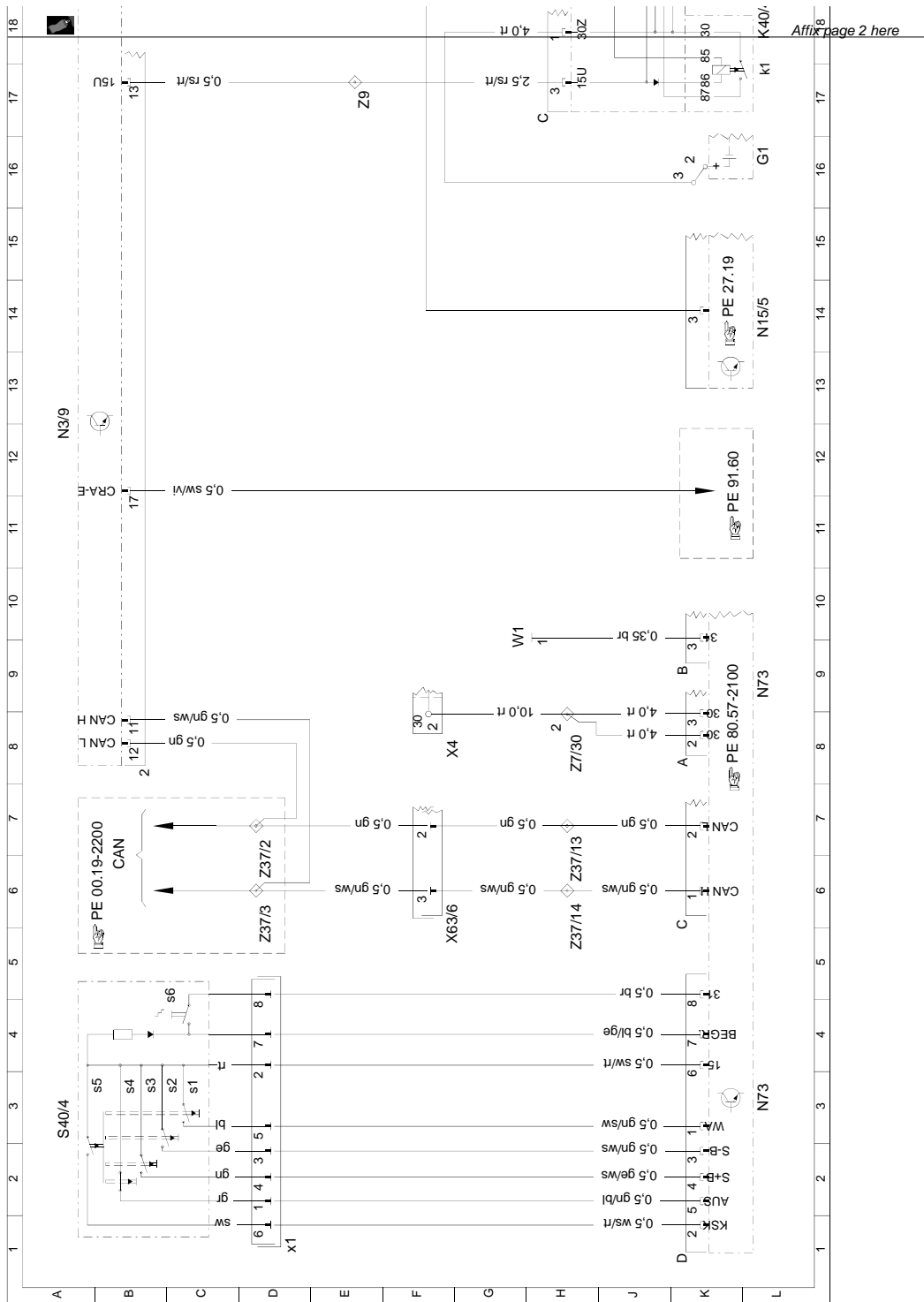

Wiring diagram of common rail diesel injection (CDI) control module / pe07.16-p-2000-99ec ENGINE 613 in MODEL 210 except CODE (491) U.S. version with CODE (440a) Cruise control plug 1 - 3, with electrical heater booster /

C W220 S320 CDI wiring diagram for reference (OM613 engine)

Please note that W220 wiring differs from W210 wiring so some wires need to be moved if fitting the DID1 ECU to a W220 S320 CDI.

C. W220 S320 CDI wiring diagram for reference (OM613 engine)

Document number: pe07.16-p-2101-99se
Document title: Wiring diagram of common rail diesel injection (CDI) control module

Code:	Designation:	Coordinates:
A6	STH or HB heater unit	42 L
B37	Accelerator pedal sensor	26 L
F1	Left fuse box	36 L
F1/1	Right fuse box	2 L
F1/1f43	Fuse 43	2 K
F1/1f44	Fuse 44	3 K
F1f6	Fuse 6	36 K
G2	Generator	19 L
K40/6	Left front fuse and relay module	33 L
K40/7	Right front fuse and relay module	7 L
M4/7	Electric suction fan engine and AC with integrated control	24 L
N14/2	Preglow output	15 L
N2/7	Restraint systems control module	29 L
N3/9	CDI control module	5 A
N3/9	CDI control module	13 A
N3/9	CDI control module	20 A
N3/9	CDI control module	27 A
N3/9	CDI control module	36 A
R9	Glow plugs	14 E
S4/3	Heater booster switch	38 L
U13	Valid for right-hand steering	36 D
W16/6	Electronics ground (right of component compartment)	3 E
W2	Ground (at right headlamp unit)	13 E
W3/7	Ground (bottom of left wheelhousing)	23 G
W36/1	Ground (right footwell)	37 G
X11/4	Data link connector	8 E
X30/4	Right voltage distributor (CAN) connector	44 A
X35/66	Compact wiring harness and diagnostic module 2 separation point, cockpit	8 G
X4/10	Terminal block and fuse box (circuit 30 and 61)	21 L
X4/10f3	Fuse 3	21 K
Y31/4	EGR [ARF]/pressure control flap vacuum transducer	10 L
Y31/5	Boost pressure control vacuum transducer	12 L
Z3	Circuit 15 connector sleeve	34 E
Z37/2	CAN engine bus (low) connector sleeve	28 E
Z37/3	CAN engine bus (high) connector sleeve	27 E
Z7/47	Circuit 87D1 connector sleeve	1 G
Z7/47	Circuit 87D1 connector sleeve	4 G
Z81/4	Circuit 58d in FSS [RBA] connector sleeve	38 G

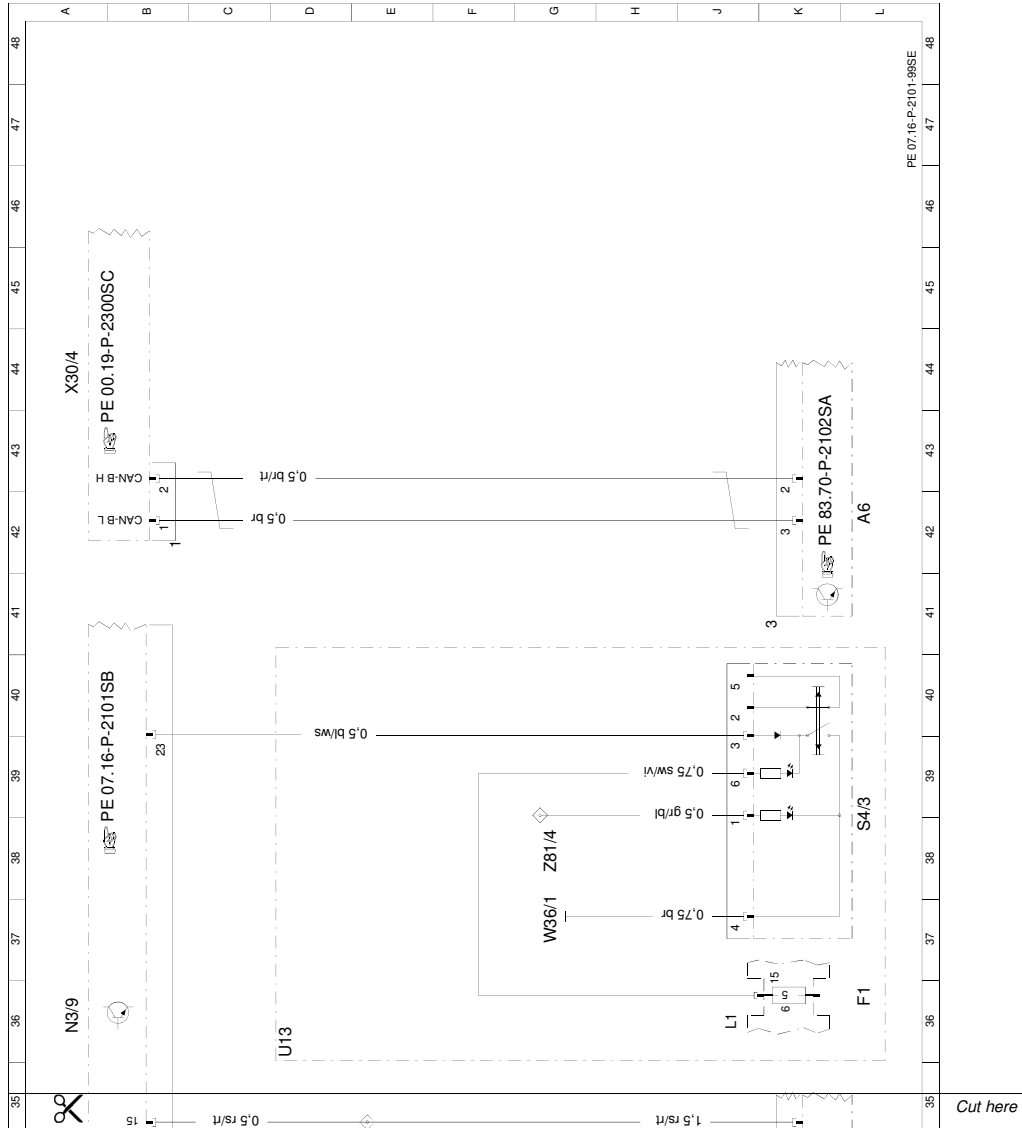

Wiring diagram of common rail diesel injection (CDI) control module / pe07.16-p-2101-99se
 ENGINE 613 as of 1.6.01 in MODEL 220 control module n3/9, sheet 1 / Printed on: 19.08.2021 / Page 3/3

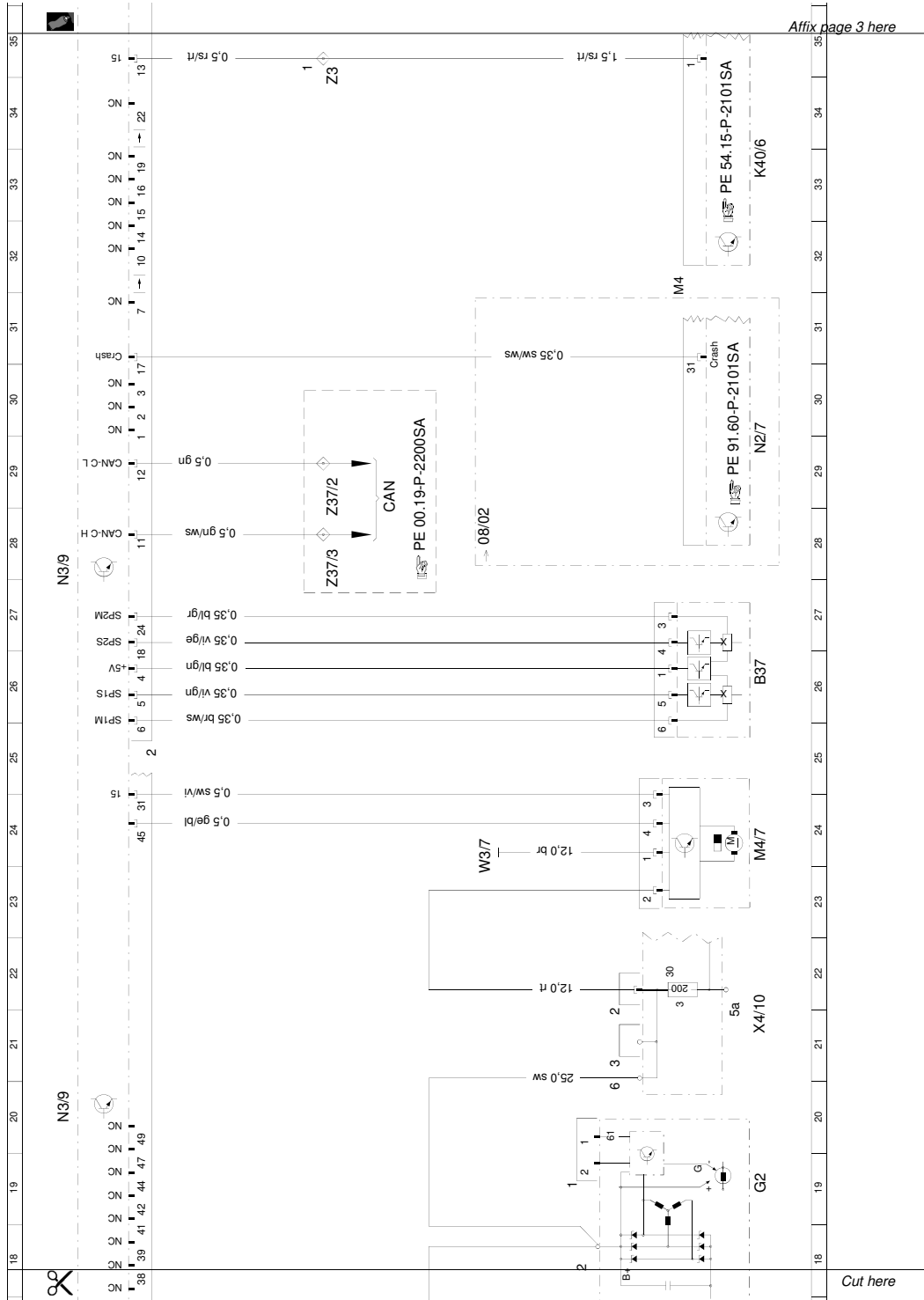

Wiring diagram of common rail diesel injection (CDI) control module / pe07.16-p-2101-99se
 ENGINE 613 as of 1.6.01 in MODEL 220 control module n3/9, sheet 1 / Printed on: 19.08.2021 / Page 2/3

C. W220 S320 CDI wiring diagram for reference (OM613 engine)

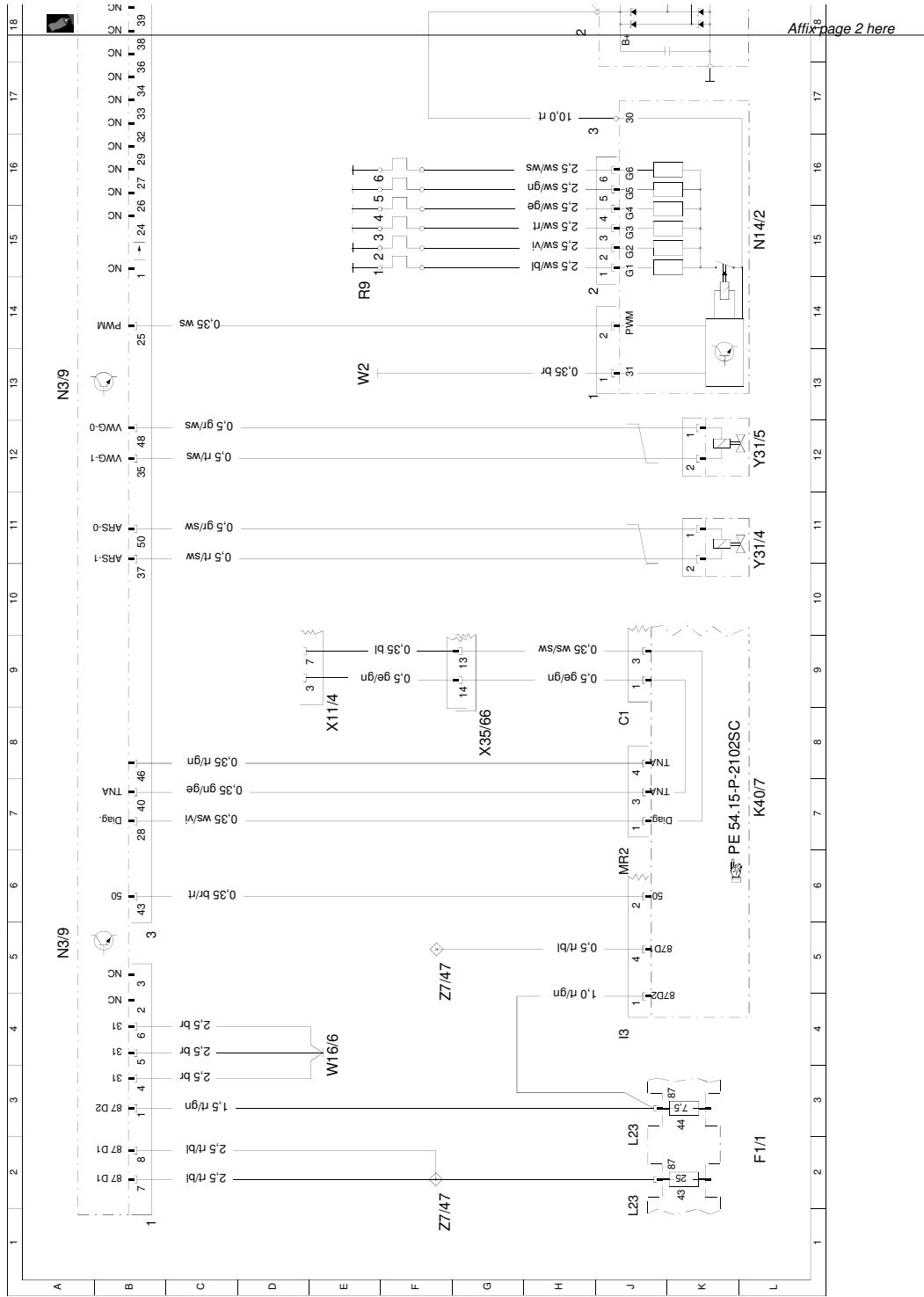

Wiring diagram of common rail diesel injection (CDI) control module / pe07.16-p-2101-99se
ENGINE 613 as of 1.6.01 in MODEL 220 control module n3/9, sheet 1 / Printed on: 19.08.2021 / Page 1/3

Document number: pe07.16-p-2101-99sb
Document title: Wiring diagram of common rail diesel injection (CDI) control module

Code:	Designation:	Coordinates:
B11/4	Coolant temperature sensor	11 L
B17	Intake air temperature sensor	10 L
B2/5	Hot film MAF sensor	20 L
B28	Pressure sensor	22 L
B4/6	Rail pressure sensor	9 L
B40	Oil sensor (oil level, temperature and quality)	14 L
B6/1	Camshaft Hall sensor	15 L
G1	Battery	30 L
G2	Generator	36 L
K40/7	Right front fuse and relay module	43 L
L5	Crankshaft position sensor	16 L
M1	Starter	28 L
M55	Inlet port shutoff motor	12 L
N3/9	CDI control module	4 A
N3/9	CDI control module	12 A
N3/9	CDI control module	20 A
N3/9	CDI control module	27 A
N33/2	Heater booster control module	24 L
S4/3	Heater booster switch	39 L
W10	Ground (battery)	30 G
X22	Engine compartment and engine connector	39 H
X4/10	Terminal block and fuse box (circuit 30 and 61)	33 L
X4/10f1	Fuse 1	32 K
X4/10f2	Fuse 2	31 K
X4/10f3	Fuse 3	33 K
Y74	Pressure regulator valve	17 L
Y75	Electrical switch-off valve	18 L
Y76	Fuel injectors	3 L
Y76y1	Fuel injector (1st cylinder)	1 L
Y76y2	Fuel injector (2nd cylinder)	5 L
Y76y3	Fuel injector (3rd cylinder)	2 L
Y76y4	Fuel injector (4th cylinder)	4 L
Y76y5	Fuel injector cylinder 5	6 L
Y76y6	Fuel injector cylinder 6	8 L
Z15	Connector sleeve 7	13 H
Z6/8	Sensor ground connector sleeve	11 H
Z99/6	Common rail solenoid valve 1 connector sleeve	2 H
Z99/7	Common rail solenoid valve 2 connector sleeve	6 H

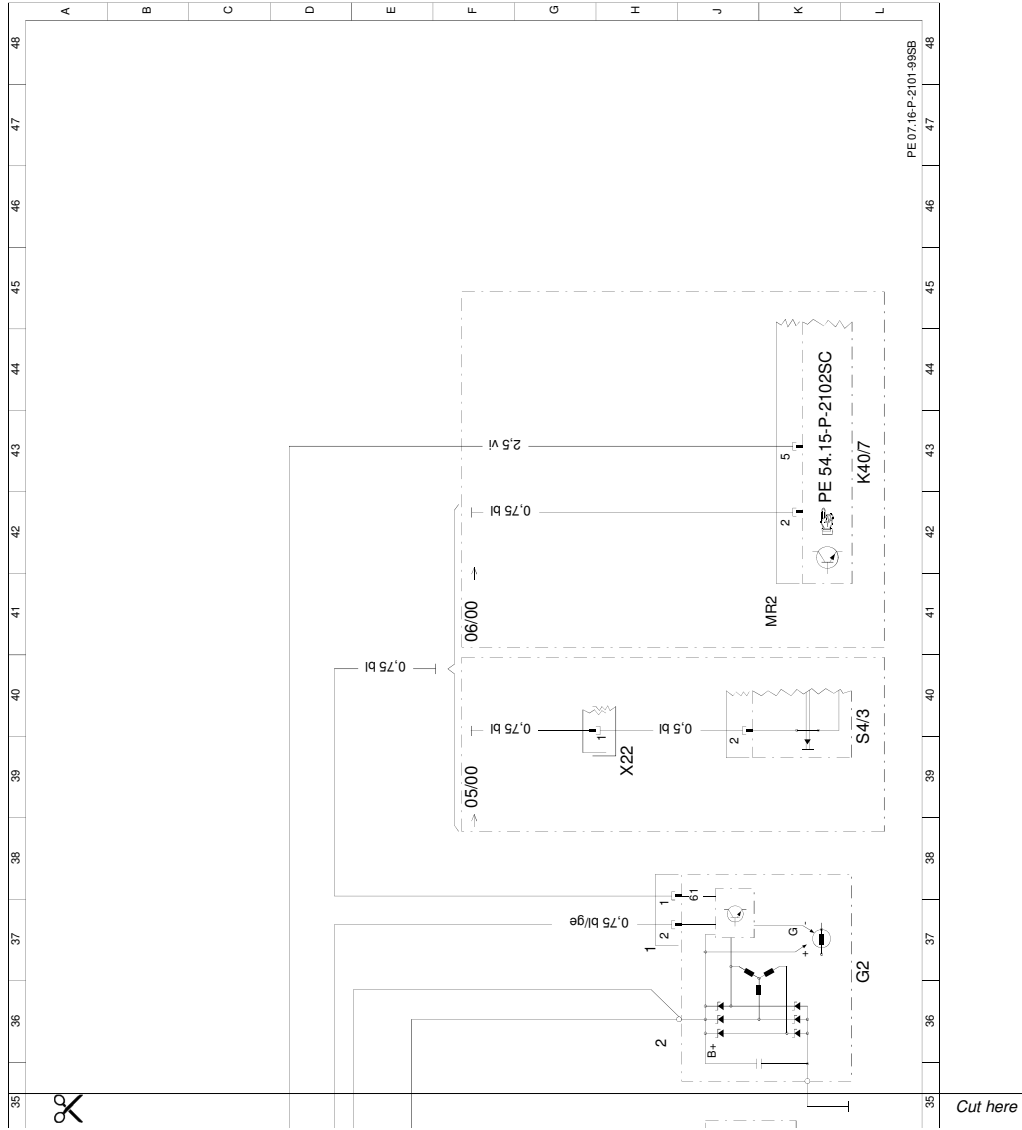

Wiring diagram of common rail diesel injection (CDI) control module / pe07.16-p-2101-99sb
ENGINE 613 in MODEL 220 control module n3/9, sheet 2 / Printed on: 19.08.2021 / Page 3/3

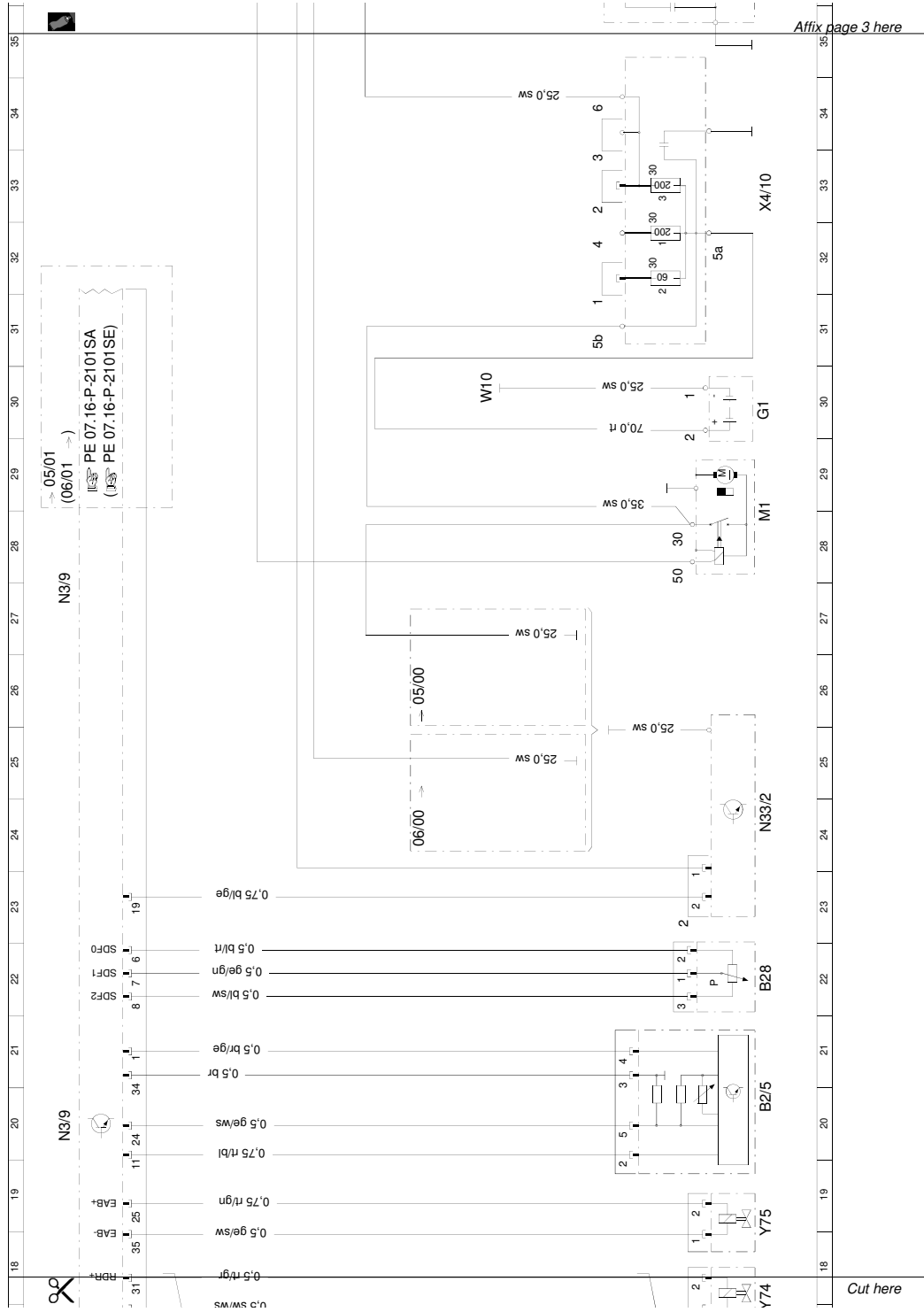

Wiring diagram of common rail diesel injection (CDI) control module / pe07.16-p-2101-99sb
ENGINE 613 in MODEL 220 control module n3/9, sheet 2 / Printed on: 19.08.2021 / Page 2/3

C. W220 S320 CDI wiring diagram for reference (OM613 engine)

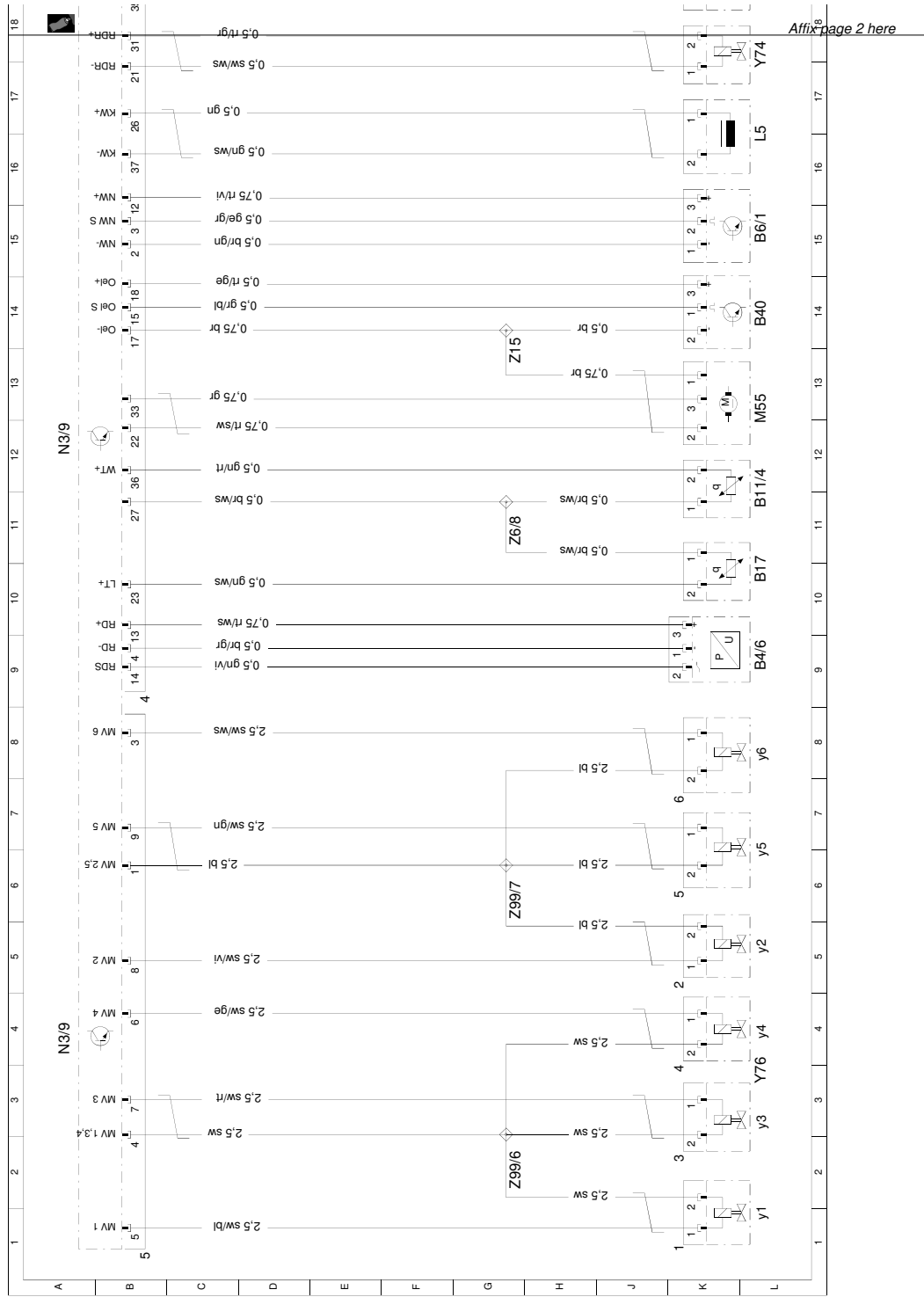

Wiring diagram of common rail diesel injection (CDI) control module / pe07.16-p-2101-99sb
ENGINE 613 in MODEL 220 control module n3/9, sheet 2 / Printed on: 19.08.2021 / Page 1/3

D. W210 E220 or E270 CDI wiring diagram for reference (OM611 or OM612 engine)

D W210 E220 or E270 CDI wiring diagram for reference (OM611 or OM612 engine)

Document number: pe07.16-p-2000-99ea
Document title: Wiring diagram of common rail diesel injection (CDI) control module

Code:	Designation:	Coordinates:
A1	Instrument cluster	69 L
A1	Instrument cluster	72 L
B17	Intake air temperature sensor	40 L
B28	Pressure sensor	41 L
B37	Accelerator pedal sensor	45 L
F1	Fuse and relay box	56 L
F1	Fuse and relay box	63 L
F1f14	Fuse 14	63 K
F1f20	Maxi-fuse 20	56 K
G1	Battery	20 L
G2	Generator	67 L
K16	Heater booster relay	61 L
K40/2	Driver-side fuse and relay module	18 E
K40/2	Driver-side fuse and relay module	52 E
K40/4	Fuse and relay module (front passenger)	22 L
K40/4	Fuse and relay module (front passenger)	28 L
K40/4	Fuse and relay module (front passenger)	73 H
K40/4f1	Fuse, circuit 30z	23 L
K40/4f2	Fuse 2, diesel engine control module power supply	29 L
K40/4f3	Fuse 1, diesel engine control module power supply	27 L
K40/4f5	Fuse, ETC/ADS [EGS/ADS]	29 L
K40/4k1	Polarity protection relay	21 L
K40/4k2	Starter relay	24 L
K40/4k3	Diesel voltage supply relay	26 L
M1	Starter	37 L
M2/2	Control module box blower motor	34 L
M4/3	Electric suction-type fan (engine / AAC)	55 L
M4/3x1	Electric suction-type fan (engine / AAC) connector	54 K
N14/2	Preglow output	48 L
N15/5	Electronic selector lever module control module	15 L
N19	AAC pushbutton control module	18 L
N22	AAC pushbutton control module	19 L
N3/9	CDI control module	13 A
N3/9	CDI control module	20 A
N3/9	CDI control module	29 A
N3/9	CDI control module	36 A
N3/9	CDI control module	44 A
N3/9	CDI control module	52 A
N3/9	CDI control module	60 A

D. W210 E220 or E270 CDI wiring diagram for reference (OM611 or OM612 engine)

Document number: pe07.16-p-2000-99ea
Document title: Wiring diagram of common rail diesel injection (CDI) control module

Code:	Designation:	Coordinates:
N3/9	CDI control module	69 A
N3/9	CDI control module	74 A
N33/2	Heater booster control module	58 L
N33/2x1	Heater booster control module connector	59 K
N73	DI control module	3 L
N73	DI control module	8 L
N76	Engine and air conditioning electric suction fan control module	53 L
R39/1	Vent line heater element	38 L
R9	Glow plugs	48 E
S16/6	Kickdown switch	11 L
S4/3	Heater booster switch	74 L
S40/3	Clutch pedal switch	13 L
S40/4	CC with variable speed limiter switch	3 A
S40/4s1	Resume from memory	3 C
S40/4s2	Decelerate and set	3 C
S40/4s3	Accelerate and set	3 B
S40/4s4	Off	3 B
S40/4s5	Control contact	3 B
S40/4s6	Variable speed	4 C
S40/4x1	Variable cruise control switch connector	1 D
U12	Valid for left-hand steering	12 J
U12	Valid for left-hand steering	12 J
U12	Valid for left-hand steering	31 D
U12	Valid for left-hand steering	37 D
U12	Valid for left-hand steering	39 D
U13	Valid for right-hand steering	11 J
U13	Valid for right-hand steering	13 J
U13	Valid for right-hand steering	30 D
U13	Valid for right-hand steering	34 H
U13	Valid for right-hand steering	36 D
U13	Valid for right-hand steering	38 D
U199	Valid for engine 612	50 H
U24	Valid for MT [MG]	10 F
U25	Valid for automatic transmission	14 F
U29	Valid for outside temperature indicator	19 H
U87	Valid for AAC [KLA]	18 H
W1	Main ground (behind instrument cluster)	9 H
W11/3	Ground (engine - left side)	39 H
W16/3	Ground (output ground-left wheel housing)	47 H

D. W210 E220 or E270 CDI wiring diagram for reference (OM611 or OM612 engine)

Document number: pe07.16-p-2000-99ea
Document title: Wiring diagram of common rail diesel injection (CDI) control module

Code:	Designation:	Coordinates:
W16/3	Ground (output ground-left wheel housing)	52 H
W16/4	Ground (output ground - right wheel housing)	25 E
W16/5	Electronics ground (left of component compartment)	30 E
W16/5	Electronics ground (left of component compartment)	36 E
W16/5	Electronics ground (left of component compartment)	38 E
W16/6	Electronics ground (right of component compartment)	31 E
W16/6	Electronics ground (right of component compartment)	37 E
W16/6	Electronics ground (right of component compartment)	39 E
W18	Ground (left front seat crossmember)	12 H
W19	Ground (right front seat crossmember)	13 H
X11/4	Data link connector	24 E
X11/4	Data link connector	30 E
X11/4	Data link connector	47 E
X12/3	Terminal block (circuit 30)	50 H
X12/3	Terminal block (circuit 30)	64 L
X12/3f1	Generator prefuse	51 G
X12/3f1	Generator prefuse	64 K
X22	Engine compartment and engine connector	67 E
X4	Terminal block (circuit 30, left footwell)	8 G
X4	Terminal block (circuit 30, left footwell)	36 H
X4	Terminal block (circuit 30, left footwell)	51 E
X4/2	Circuit 30 connector, heater booster, generator	64 E
X4/3	Circuit 30 connector, heater booster, battery	63 H
X63/6	CAN databus/15u connector	5 G
Y31/4	EGR [ARF]/pressure control flap vacuum transducer	42 L
Y31/5	Boost pressure control vacuum transducer	43 L
Z26	Circuit 61e connector sleeve	74 E
Z37/13	CAN engine bus (low) connector sleeve	6 H
Z37/14	CAN engine bus (high) connector sleeve	5 H
Z37/2	CAN engine bus (low) connector sleeve	6 D
Z37/3	CAN engine bus (high) connector sleeve	5 D
Z7/24	Circuit 87 connector sleeve	29 E
Z7/30	Circuit 30 (unfused) connector sleeve	7 H
Z9	Connector sleeve 1	9 E
Z9	Connector sleeve 1	21 E

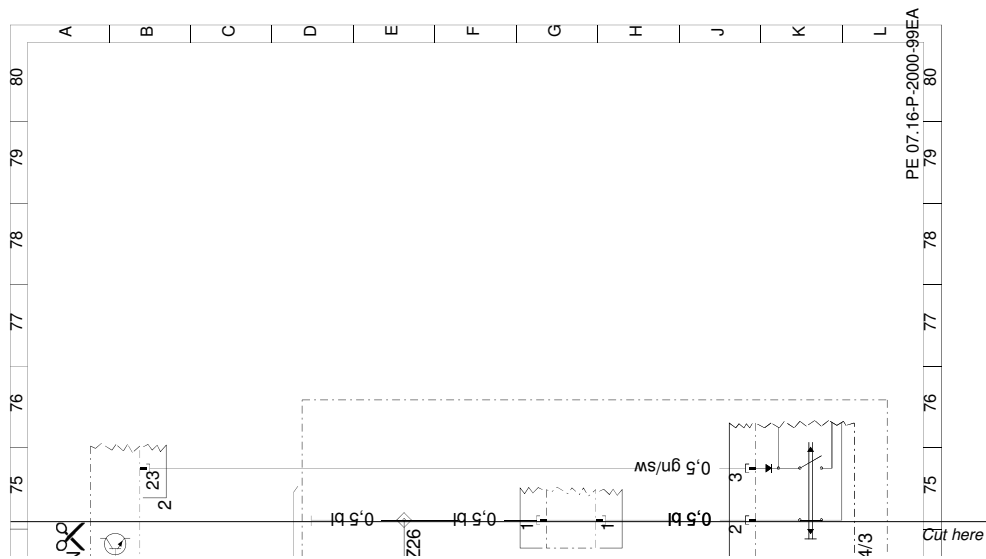

Wiring diagram of common rail diesel injection (CDI) control module / pe07.16-p-2000-99ea ENGINE 611 as of 1.6.99, 612 in MODEL 210 with CODE (440a) Cruise control connectors 1 - 3, with electric heater booster / Printed on: 15.12.20

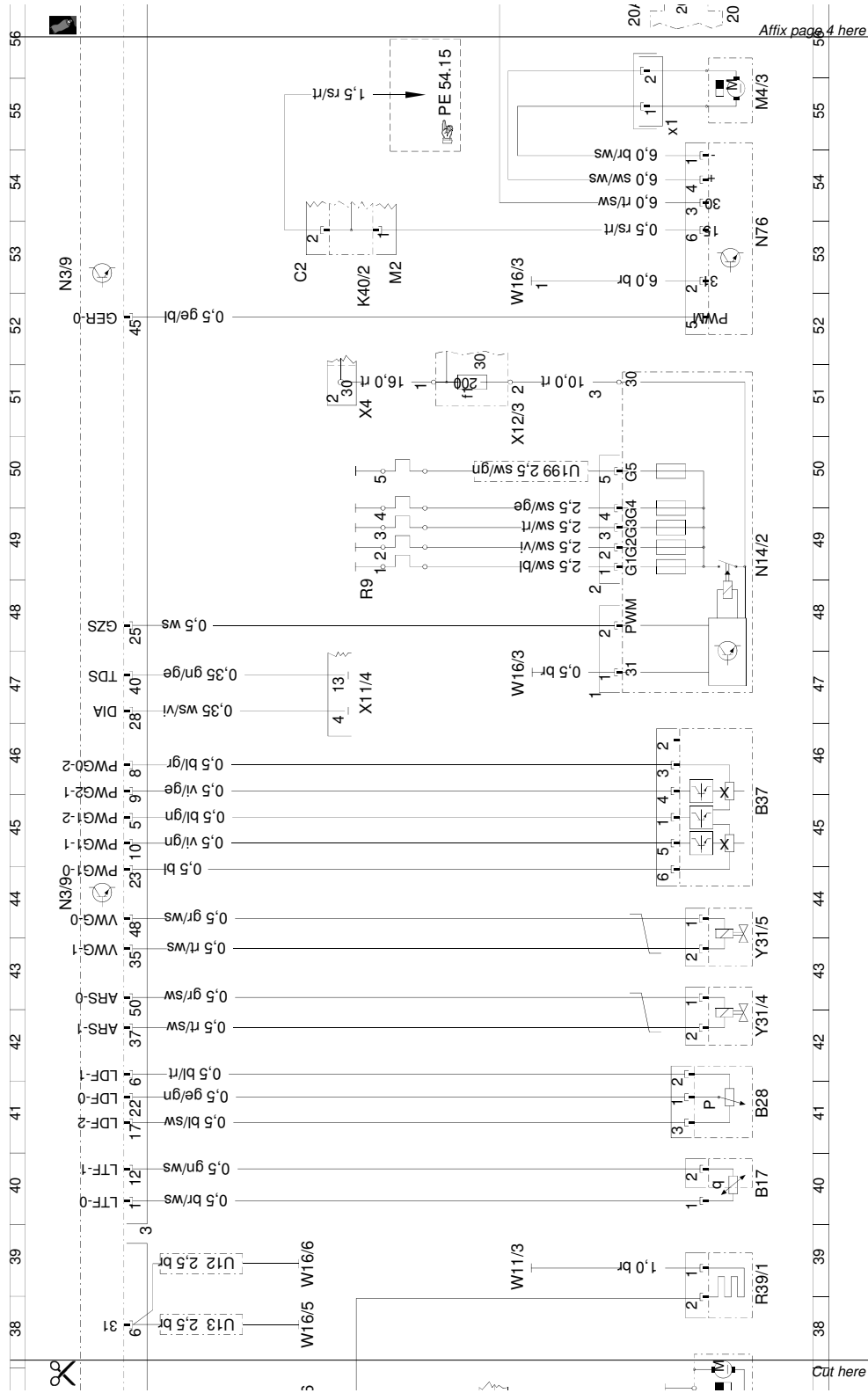

Wiring diagram of common rail diesel injection (CDI) control module / pe07.16-p-2000-99ea ENGINE 611 as of 1.6.99, 612 in MODEL 210 with CODE (440a) Cruise control connectors 1 - 3, with electric heater booster / Printed on: 15.12.21

D. W210 E220 or E270 CDI wiring diagram for reference (OM611 or OM612 engine)

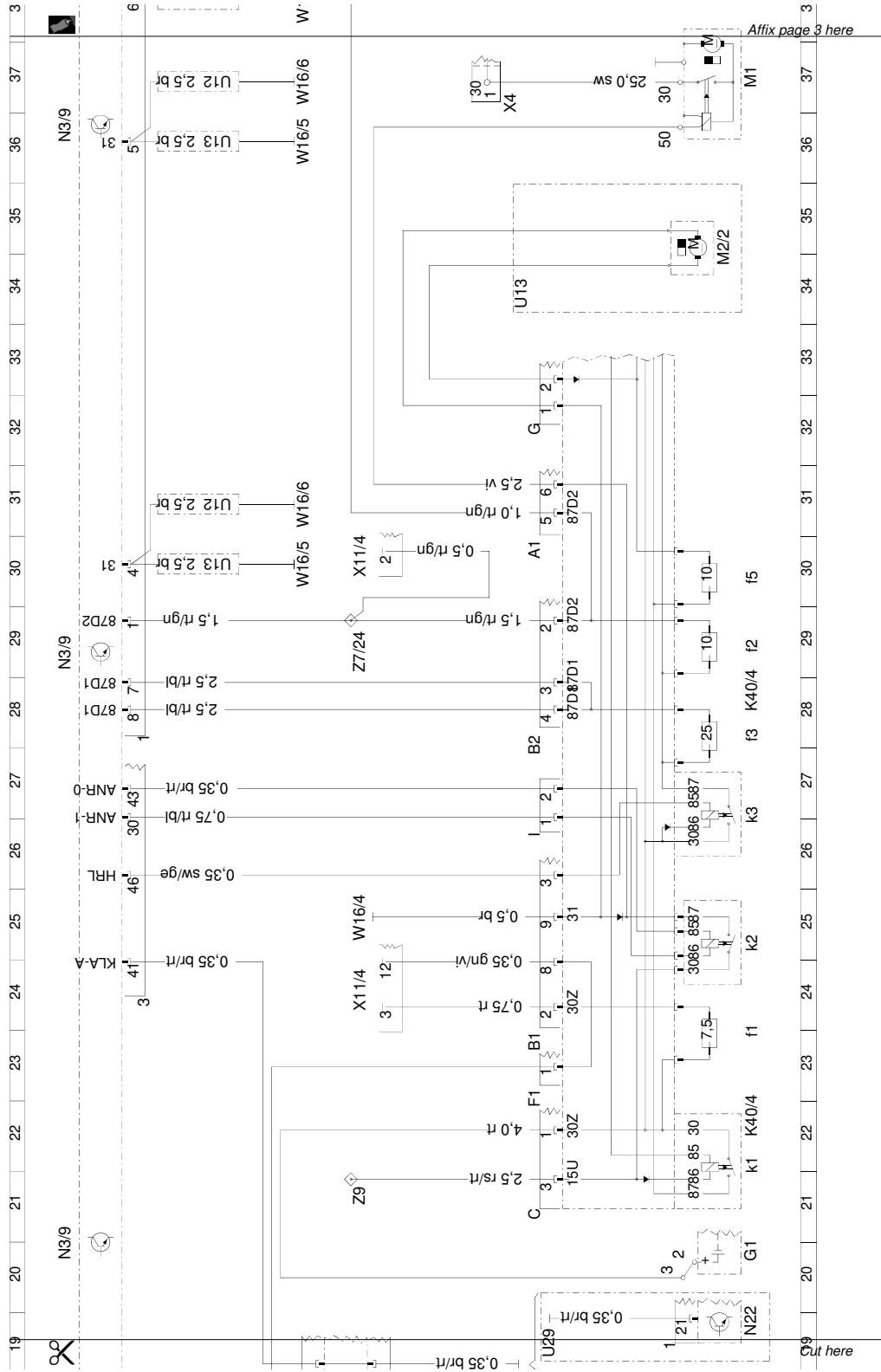

Wiring diagram of common rail diesel injection (CDI) control module / pe07.16-p-2000-99ea ENGINE 611 as of 1.6.99, 612 in MODEL 210 with CODE (440a) Cruise control connectors 1 - 3, with electric heater booster / Printed on: 15.12.21

D. W210 E220 or E270 CDI wiring diagram for reference (OM611 or OM612 engine)

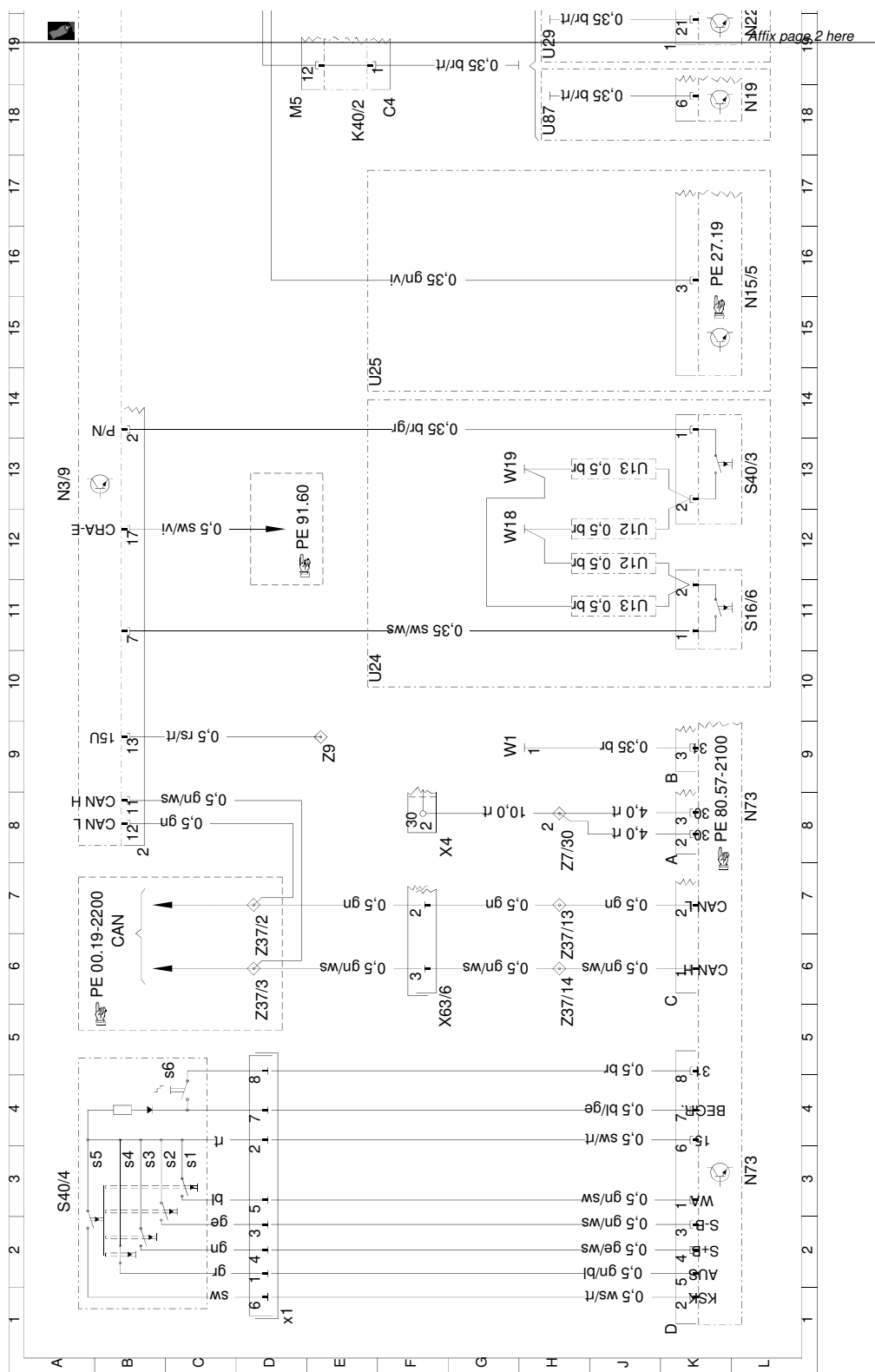

Affix page 2 here

Wiring diagram of common rail diesel injection (CDI) control module / pe07.16-p-2000-99ea ENGINE 611 as of 1.6.99, 612 in MODEL 210 with CODE (440a) Cruise control connectors 1 - 3, with electric heater booster / Printed on: 15.12.21

D. W210 E220 or E270 CDI wiring diagram for reference (OM611 or OM612 engine)

Document number: pe07.16-p-2000-99eb
Document title: Wiring diagram of common rail diesel injection (CDI) control module

Code:	Designation:	Coordinates:
B11/4	Coolant temperature sensor	15 L
B2/5	Hot film MAF sensor	24 L
B4/6	Rail pressure sensor	14 L
B40	Oil sensor (oil level, temperature and quality)	18 L
B6/1	Camshaft Hall sensor	19 L
L5	Crankshaft position sensor	20 L
M55	Inlet port shutoff motor	16 L
N3/9	CDI control module	4 A
N3/9	CDI control module	12 A
N3/9	CDI control module	19 A
U198	Valid for engine 611	1 A
U199	Valid for engine 612	7 A
Y74	Pressure regulator valve	21 L
Y75	Electrical switch-off valve	22 L
Y76	Injectors (LH-SFI, HFM-SFI, PEC [LH, HFM, PMS])	4 L
Y76	Injectors (LH-SFI, HFM-SFI, PEC [LH, HFM, PMS])	9 L
Y76y1	Injector cylinder 1	2 L
Y76y1	Injector cylinder 1	7 L
Y76y2	Injector cylinder 2	4 L
Y76y2	Injector cylinder 2	11 L
Y76y3	Injector cylinder 3	5 L
Y76y3	Injector cylinder 3	9 L
Y76y4	Injector cylinder 4	3 L
Y76y4	Injector cylinder 4	10 L
Y76y5	Fuel injector cylinder 5	12 L
Z15	Connector sleeve 7	17 H
Z99/6	Common rail solenoid valve 1 connector sleeve	2 H
Z99/6	Common rail solenoid valve 1 connector sleeve	8 H
Z99/7	Common rail solenoid valve 2 connector sleeve	5 H
Z99/7	Common rail solenoid valve 2 connector sleeve	12 H

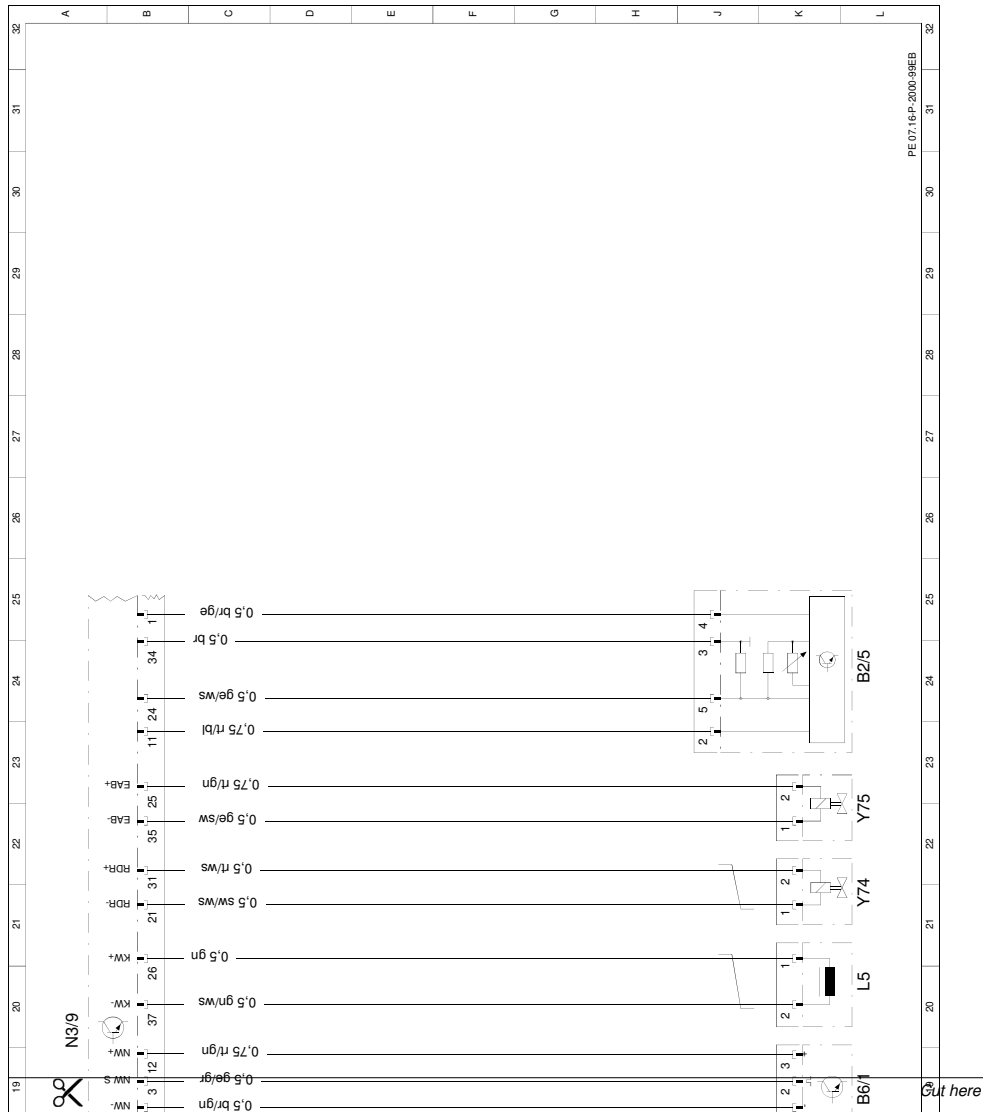

Wiring diagram of common rail diesel injection (CDI) control module / pe07.16-p-2000-99eb ENGINE 611 as of 1.6.99, 612 in MODEL 210 connectors 4 and 5 / Printed on: 15.12.2019 / Page 2/2

D. W210 E220 or E270 CDI wiring diagram for reference (OM611 or OM612 engine)

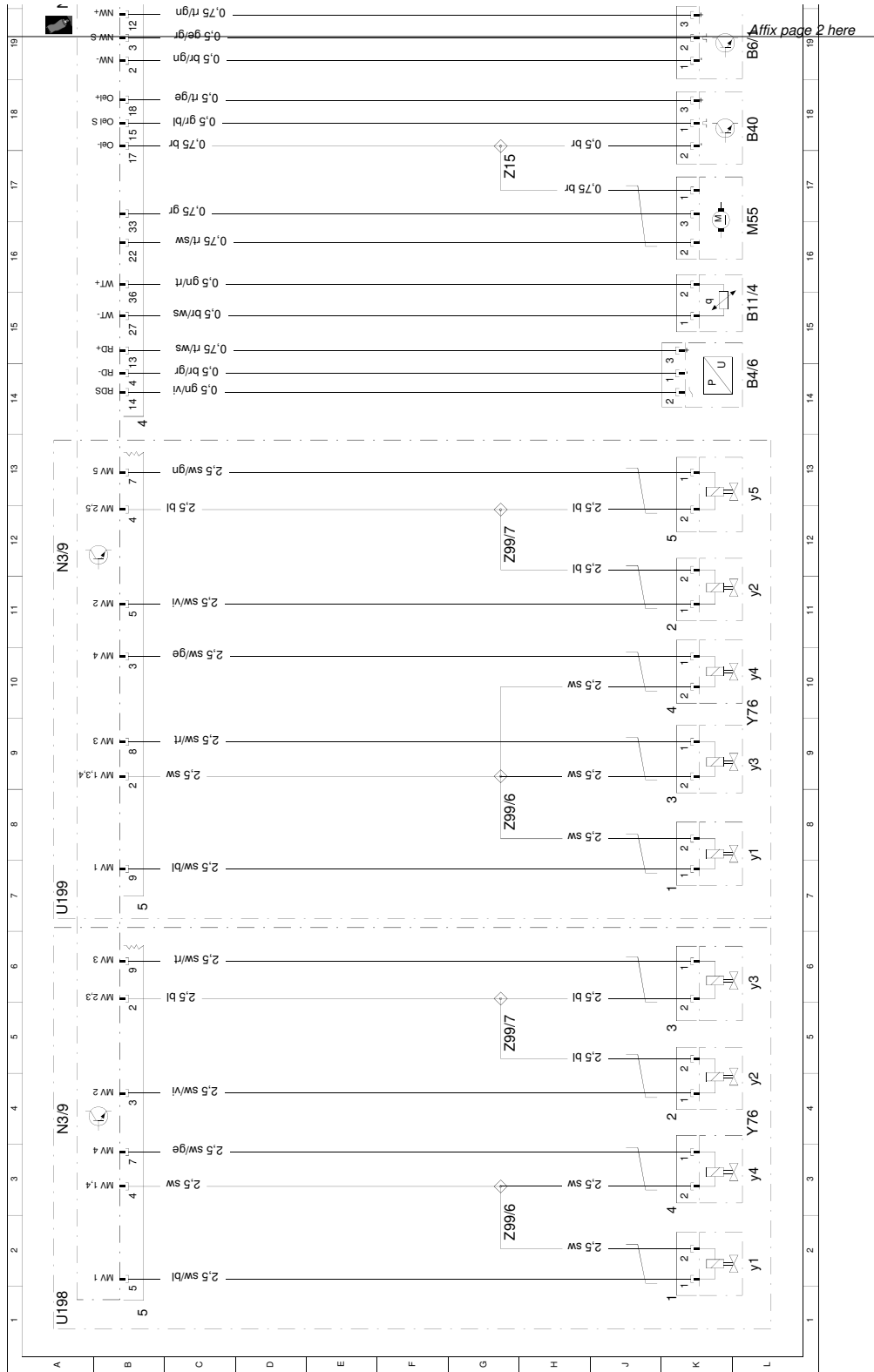

Wiring diagram of common rail diesel injection (CDI) control module / pe07.16-p-2000-99eb ENGINE 611 as of 1.6.99, 612 in MODEL 210 connectors 4 and 5 / Printed on: 15.12.2019 / Page 1/2

E W163 ML270 CDI wiring diagram for reference (OM612 engine)

Document number: pe07.16-p-2000-99gh
Document title: Wiring diagram of common rail diesel injection (CDI) control module

Code:	Designation:	Coordinates:
B11/4	Coolant temperature sensor	40 L
B17	IAT sensor	33 L
B2/5	Hot film MAF sensor	35 L
B28	Pressure sensor	30 L
B4/6	Rail pressure sensor	48 L
B40	Oil sensor (oil level, temperature and quality)	45 L
B6/1	Camshaft Hall sensor	37 L
F1	Fuse and relay module	2 C
F1	Fuse and relay module	27 C
F1f14	Fuse 14	11 C
F1k11	Circuit 15 delayed relay	9 D
F1k12	Circuit 15 relay	5 D
F24/8	Circuit 15 auxiliary fuse	11 L
G1	Battery	4 H
L5	Crankshaft position sensor	42 L
M55	Inlet port shutoff motor	46 L
N10	All-activity module	4 A
N10	All-activity module	10 A
N14/2	Preglow output	24 L
N3/9	CDI control module	17 A
N3/9	CDI control module	27 A
N3/9	CDI control module	37 A
N3/9	CDI control module	47 A
N3/9	CDI control module	56 A
R39/1	Vent line heater element	17 L
R9	Glow plugs	24 C
R9	Glow plugs	24 C
R9	Glow plugs	25 C
R9	Glow plugs	25 C
R9	Glow plugs	26 C
S2	Starter switch	3 L
W11/3	Ground (engine - left side)	16 H
W16/4	Ground (output ground - component compartment - right)	6 L
W16/5	Electronics ground (left of component compartment)	18 F
W2	Ground (at right headlamp unit)	23 C
X12/3	Terminal block (circuit 30, 15, 31, 3-pin)	4 E
X12/3	Terminal block (circuit 30, 15, 31, 3-pin)	27 E
X18/31	Left engine compartment/right engine compartment connector	29 G
X22	Engine compartment and engine connector	17 G

Document number: pe07.16-p-2000-99gh
Document title: Wiring diagram of common rail diesel injection (CDI) control module

Code:	Designation:	Coordinates:
X4/37	Circuit 30 terminal block	4 F
Y31/5	Boost pressure control vacuum transducer	28 L
Y74	Pressure regulator valve	43 L
Y75	Electrical switch-off valve	39 L
Y76y1	Fuel injector (1st cylinder)	50 L
Y76y2	Fuel injector (2nd cylinder)	54 L
Y76y3	Fuel injector (3rd cylinder)	53 L
Y76y4	Fuel injector (4th cylinder)	51 L
Y76y5	UNBEKANNT	56 L
Z18	Connector sleeve 10	45 F
Z50/5	Cockpit connector sleeve (circuit 30)	2 G
Z50/6	Cockpit connector sleeve (circuit 15C)	1 H
Z50/9	Cockpit connector sleeve II (circuit 15)	1 G
Z57/11	Right engine compartment, circuit 15 connector sleeve	15 F
Z57/7	Connector sleeve in right of engine compartment, circuit 31 (3)	18 D
Z57/7	Connector sleeve in right of engine compartment, circuit 31 (3)	23 F
Z99/6	Common rail solenoid valve 1 connector sleeve	50 G
Z99/7	Common rail solenoid valve 2 connector sleeve	54 G

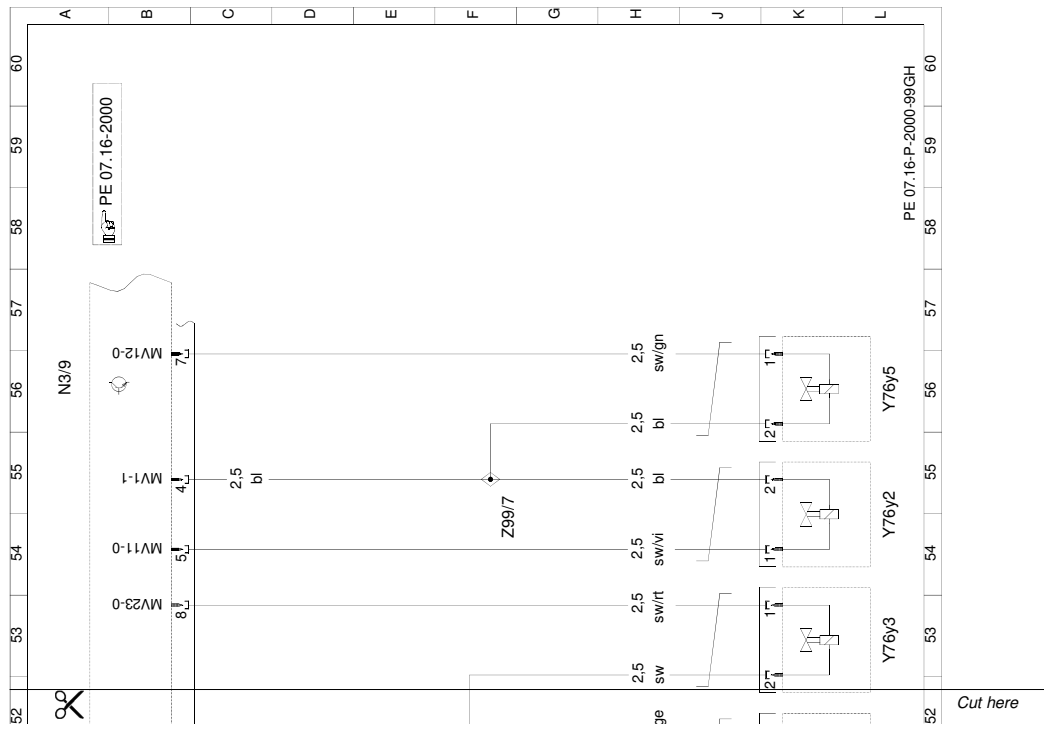

Wiring diagram of common rail diesel injection (CDI) control module / pe07.16-p-2000-99gh
ENGINE 612 in MODEL 163 up to 31.8.01 Engine block wiring harnesses / Printed on: 07.12.2019 / Page 4/4

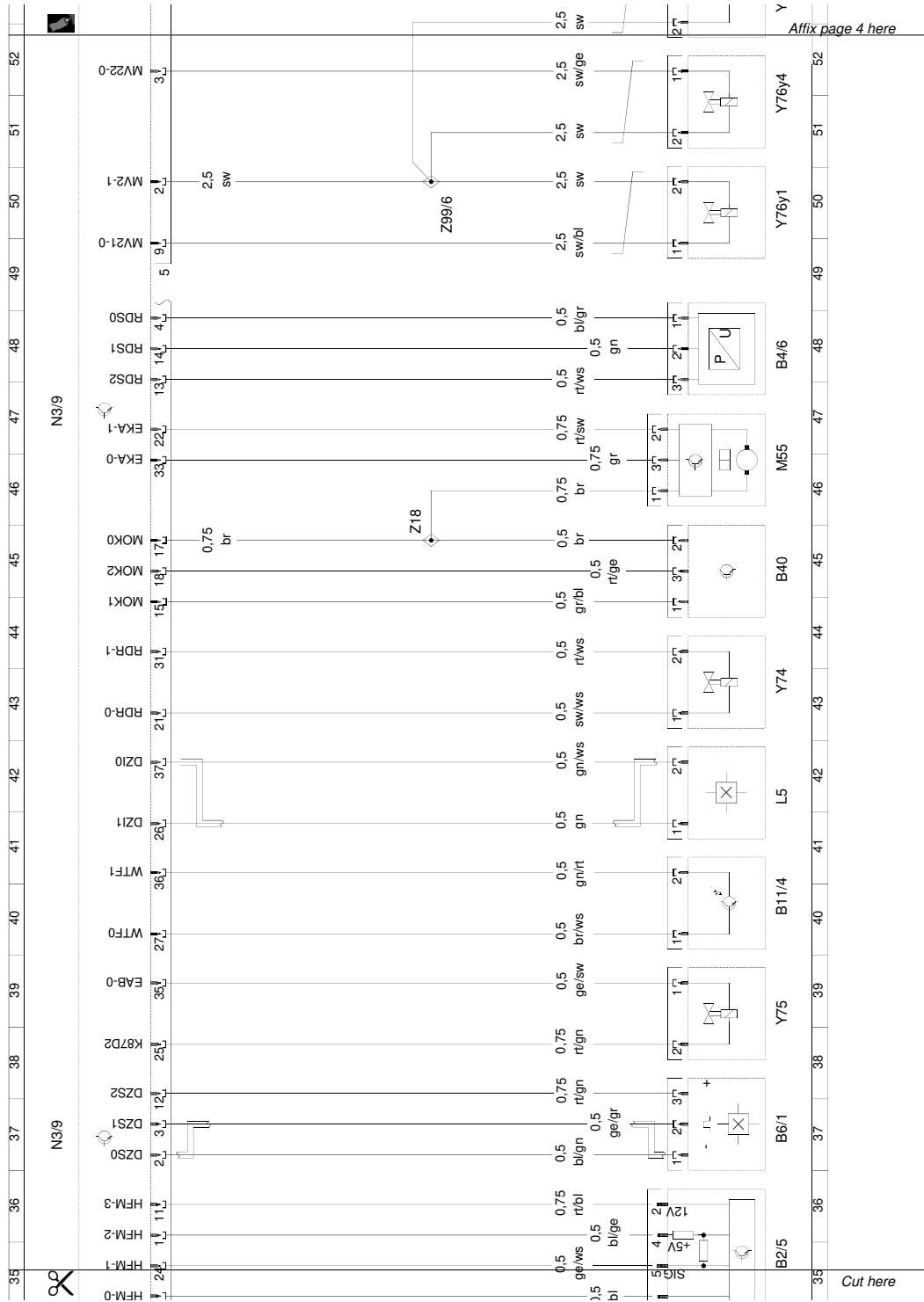

Wiring diagram of common rail diesel injection (CDI) control module / pe07.16-p-2000-99gh
 ENGINE 612 in MODEL 163 up to 31.8.01 Engine block wiring harnesses / Printed on: 07.12.2019 / Page 3/4

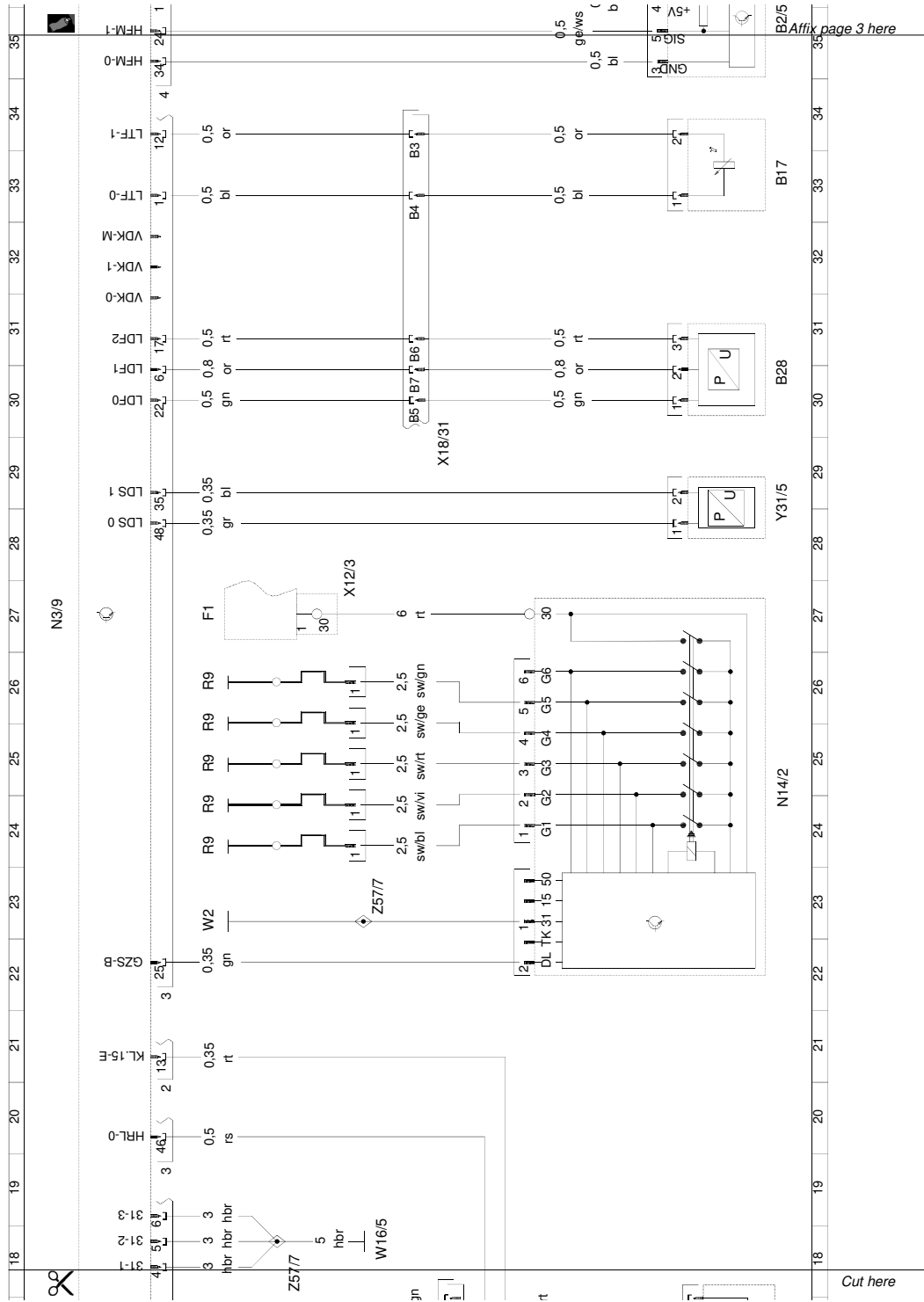

Wiring diagram of common rail diesel injection (CDI) control module / pe07.16-p-2000-99gh
 ENGINE 612 in MODEL 163 up to 31.8.01 Engine block wiring harnesses / Printed on: 07.12.2019 / Page 2/4

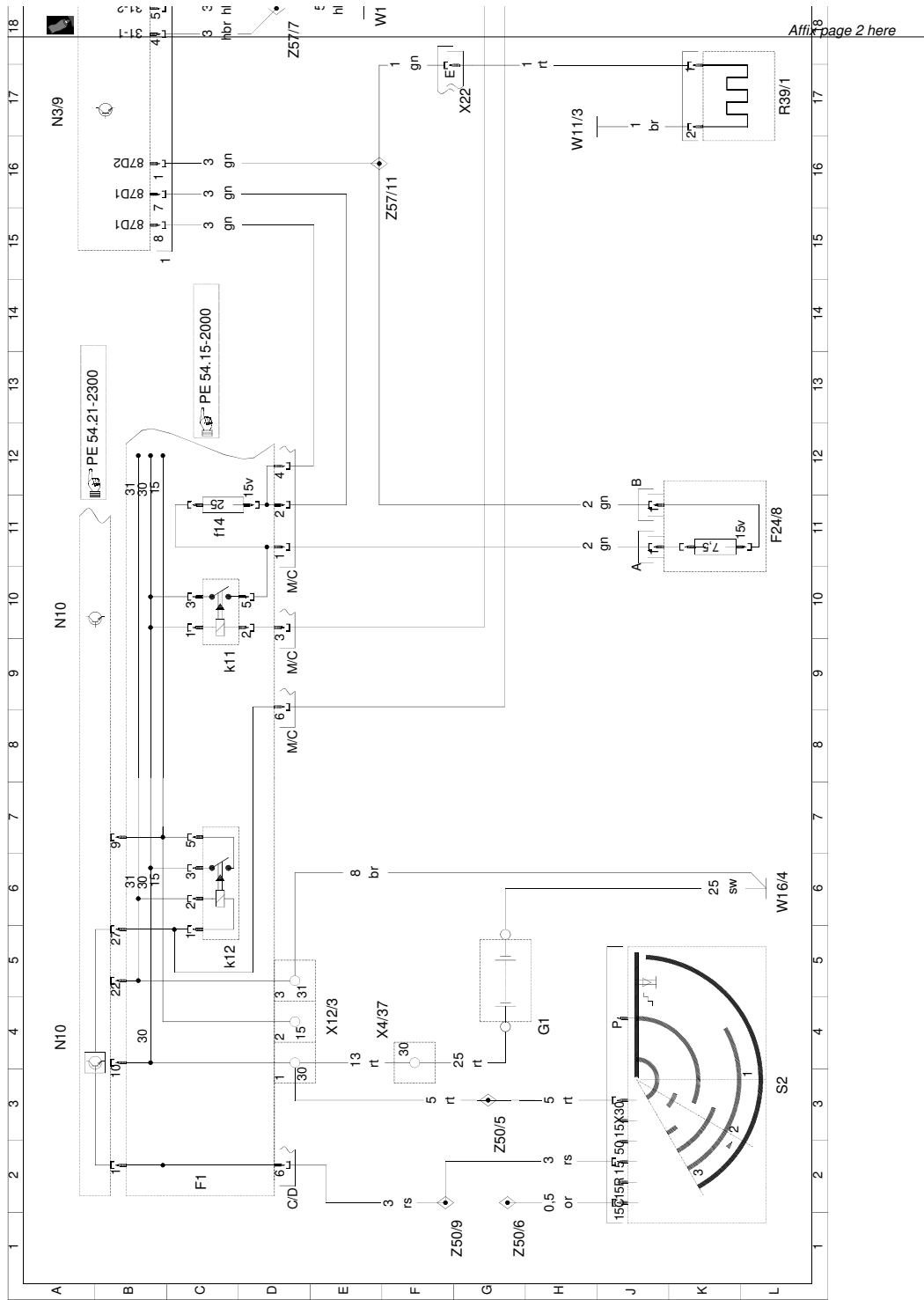

Wiring diagram of common rail diesel injection (CDI) control module / pe07.16-p-2000-99gh
 ENGINE 612 in MODEL 163 up to 31.8.01 Engine block wiring harnesses / Printed on: 07.12.2019 / Page 1/4

Document number: pe07.16-p-2000-99go
Document title: Wiring diagram of common rail diesel injection (CDI) control unit

Code:	Designation:	Coordinates:
B37	Accelerator pedal sensor	43 L
F1	Fuse and relay module	1 C
F1	Fuse and relay module	26 L
F1f14	Fuse 14	12 C
F1k11	Diesel voltage supply relay	10 C
F1k12	Circuit 15 relay	5 C
F24/7	Circuit 30 auxiliary fuse, suction fan	40 G
F24/8	Circuit 15 auxiliary fuse	12 L
G1	Battery	4 H
G1	Battery	39 F
M4/7	Electric suction fan engine and AC with integrated control	38 L
N10	All-activity module	4 A
N10	All-activity module	11 A
N10/1	Extended Activity module (EAM)	50 A
N2/7	Restraint systems control module	31 L
N3/9	CDI control module	18 A
N3/9	CDI control module	28 A
N3/9	CDI control module	39 A
S16/6	Kickdown switch	27 L
S2	Starter switch	3 L
S40/3	Clutch pedal switch	7 L
S40/4	CC with variable speed limiter switch	50 L
S40/4s1	Resume from memory	47 J
S40/4s2	Decelerate and set	51 J
S40/4s3	Accelerate and set	50 J
S40/4s4	Off	47 J
S40/4s5	Control contact	50 J
S40/4s6	Variable speed	51 K
S40/4v1	Yellow LED, variable speed limiter	51 K
U24	Valid for MT [MG]	6 E
W16/4	Ground (output ground - component compartment - right)	5 L
W16/4	Ground (output ground - component compartment - right)	40 C
W16/5	Electronics ground (left of component compartment)	19 F
W2	Ground (at right headlamp unit)	39 C
W29/2	Ground (right A-pillar)	7 F
X12/12	Circuit 30 terminal block at relay module 1	2 E
X12/13	Circuit 15 terminal block at relay module 1	4 E
X12/14	Circuit 31 terminal block at relay module 1	5 E
X25/2	Engine compartment/interior compartment connector	25 G

Document number: pe07.16-p-2000-99go
Document title: Wiring diagram of common rail diesel injection (CDI) control unit

Code:	Designation:	Coordinates:
X26	Engine compartment/cockpit connector	22 F
X4/37	Terminal block (circuit 30)	4 F
Z37/2	CAN engine bus (low) connector sleeve	32 D
Z37/3	CAN engine bus (high) connector sleeve	32 D
Z50/11	CAN-L cockpit connector sleeve	53 D
Z50/12	CAN-H cockpit connector sleeve	52 D
Z50/3	Cockpit connector sleeve (circuit 31, I left)	51 F
Z50/4	Cockpit connector sleeve (circuit 31, II right)	6 H
Z50/5	Cockpit circuit 30 connector sleeve	2 G
Z50/6	Cockpit connector sleeve (circuit 15C)	1 H
Z50/9	Cockpit connector sleeve (circuit 15 II)	1 F
Z51/14	Interior connector sleeve, analog crash signal	30 J
Z51/3	Interior connector sleeve (CAN-High 2)	33 J
Z51/4	Interior connector sleeve (CAN-Low 2)	32 J
Z51/8	Interior connector sleeve II (circuit 31, right front)	27 H
Z57/11	Right engine compartment, circuit 15 connector sleeve	17 F
Z57/7	Right engine compartment connector sleeve, circuit 31 (3)	18 E

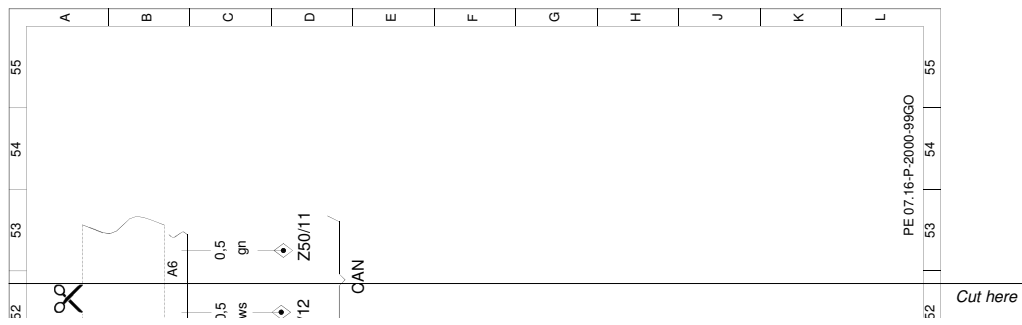

Wiring diagram of common rail diesel injection (CDI) control unit / pe07.16-p-2000-99go
ENGINE 612 in MODEL 163 as of 1.9.02 / Printed on: 07.12.2019 / Page 4/4

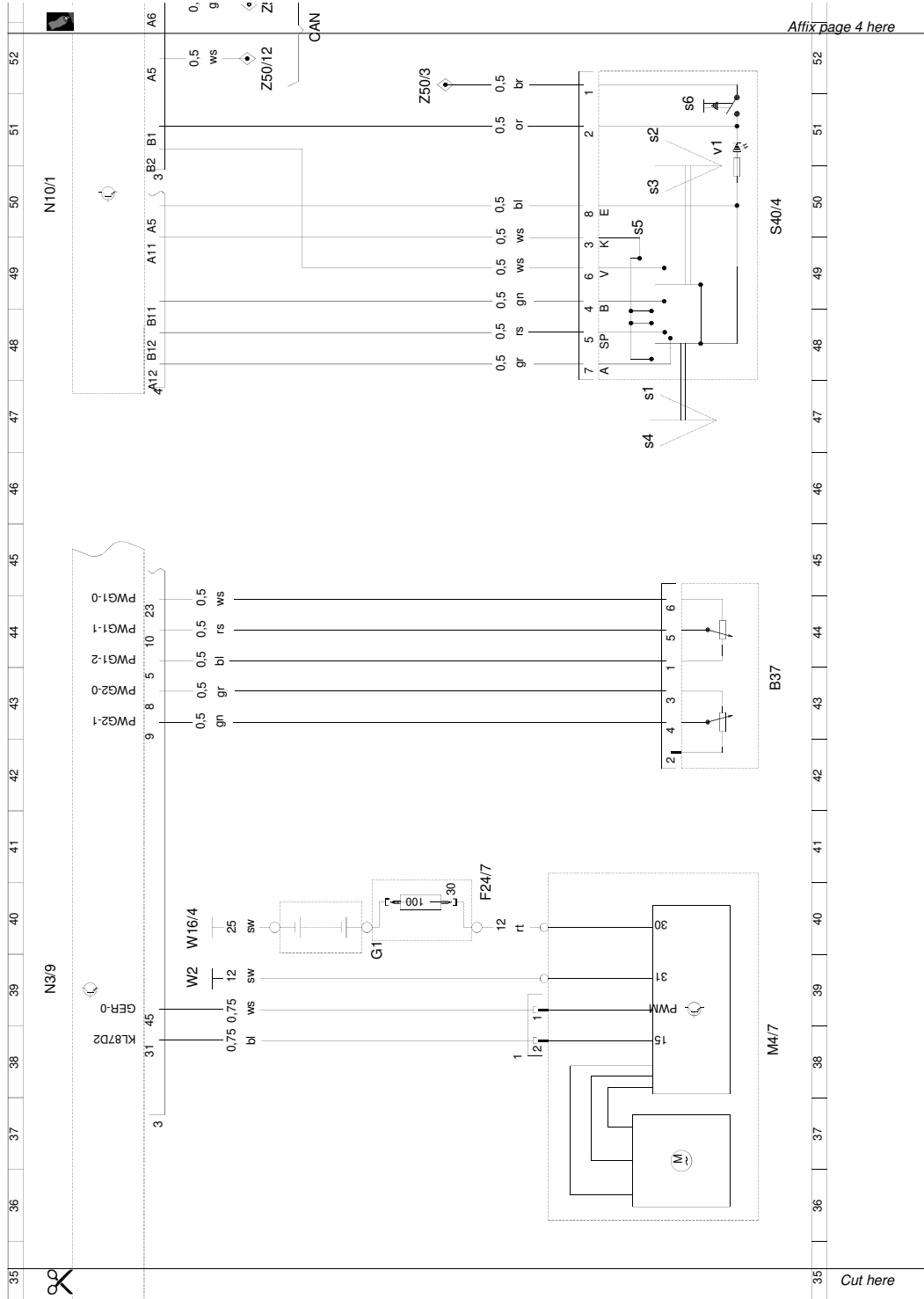

Wiring diagram of common rail diesel injection (CDI) control unit / pe07.16-p-2000-99go
ENGINE 612 in MODEL 163 as of 1.9.02 / Printed on: 07.12.2019 / Page 3/4

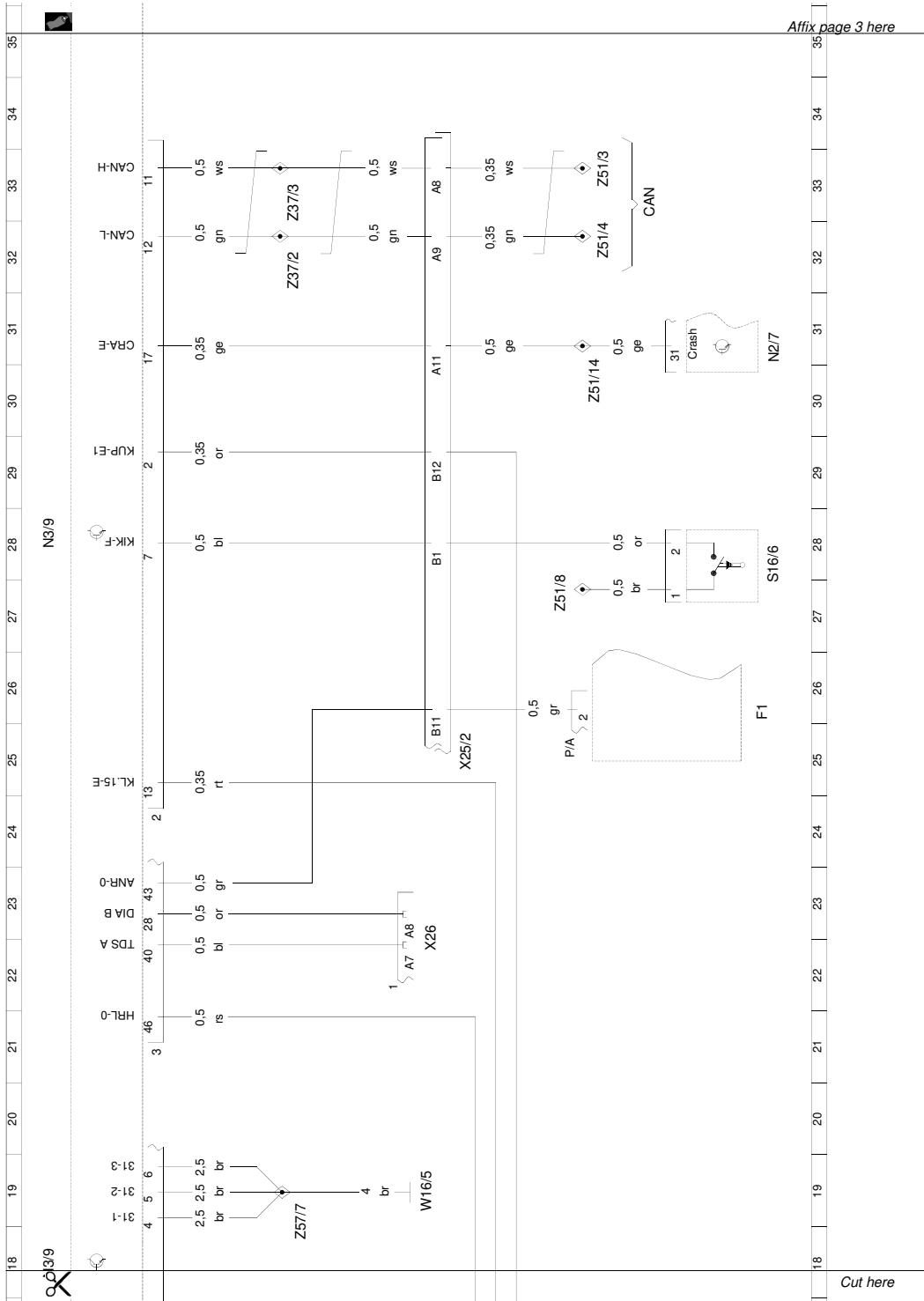

Wiring diagram of common rail diesel injection (CDI) control unit / pe07.16-p-2000-99go
ENGINE 612 in MODEL 163 as of 1.9.02 / Printed on: 07.12.2019 / Page 2/4

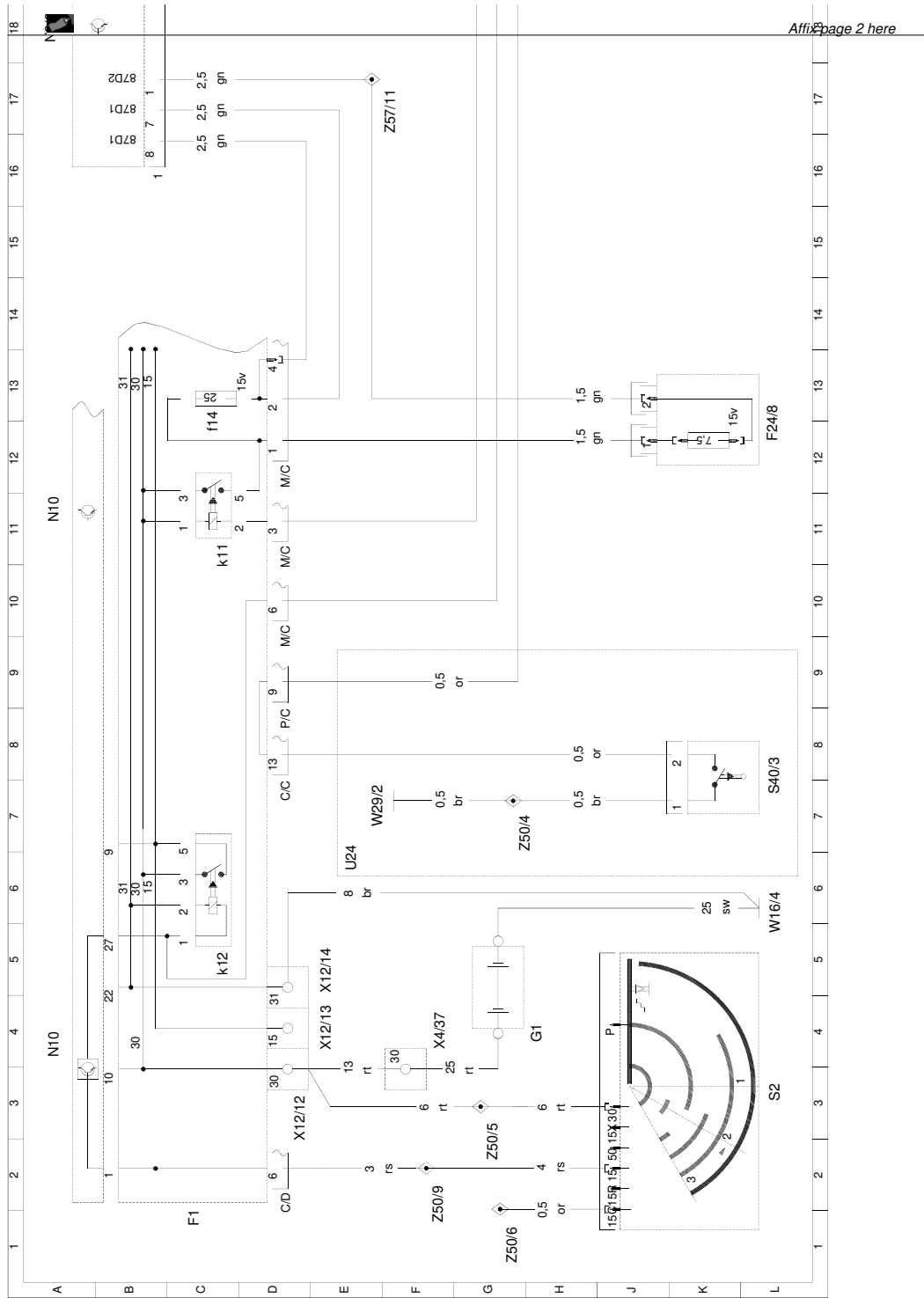

Wiring diagram of common rail diesel injection (CDI) control unit / pe07.16-p-2000-99go
ENGINE 612 in MODEL 163 as of 1.9.02 / Printed on: 07.12.2019 / Page 1/4

F Mercedes OM648 wiring

The following diagram shows the factory wiring of the OM648 engine as fitted to W211 E320 CDI cars. This chapter contains wiring guidelines for this engine when fitting to the DID1 ECU.

Engine devices:

Injector 1 (Y76y1)

Device pin	Wire colour	Function	OEM pin	DID1 pin
1	black/blue	Negative	1/49	5/5
2	blue	Positive	1/2	5/4

Injector 2 (Y76y2)

Device pin	Wire colour	Function	OEM pin	DID1 pin
1	black/violet	Negative	1/50	5/8
2	blue/violet	Positive	1/3	5/4

Injector 3 (Y76y3)

Device pin	Wire colour	Function	OEM pin	DID1 pin
1	black/red	Negative	1/73	5/7
2	blue/red	Positive	1/1	5/4

Injector 4 (Y76y4)

Device pin	Wire colour	Function	OEM pin	DID1 pin
1	black/yellow	Negative	1/75	5/6
2	blue/yellow	Positive	1/27	5/4

Injector 5 (Y76y5)

Device pin	Wire colour	Function	OEM pin	DID1 pin
1	black/green	Negative	1/74	5/9
2	blue/green	Positive	1/25	5/4

Injector 6 (Y76y6)

Device pin	Wire colour	Function	OEM pin	DID1 pin
1	black/white	Negative	1/51	5/3
2	blue/white	Positive	1/26	5/4

Volume control valve (Y94) Connects to output 4

Device pin	Wire colour	Function	OEM pin	DID1 pin
1	yellow/black	+12V	1/76	3/37
2	black/yellow	Negative	1/28	3/50

Oil level sensor (B40) Optional. Connects to any digital input capable of frequency input (input 1, 3, 4, 5, or on controllers with serial number 200 and up inputs 6 and 7 can also be used)

Suggested wiring for controllers with serial numbers from 200 and up:

Device pin	Wire colour	Function	OEM pin	DID1 pin
1	grey/blue	signal	1/11	4/15 digital in 6
2	brown/blue	return	1/35	4/17
3	red/yellow	+5V	1/10	4/18

Suggested wiring for older controllers:

Device pin	Wire colour	Function	OEM pin	DID1 pin
1	grey/blue	signal	1/11	3/22 digital in 3
2	brown/blue	return	1/35	3/41
3	red/yellow	+5V	1/10	3/40

Vent line heater (R39/1) Not ECU controlled. Wire to switched 12V supply or omit.

Fuel temperature sensor (B50) Optional. Skip or connect to analog input with 3k pull up.

Device pin	Wire colour	Function	OEM pin	DID1 pin
1	blue/green	return	1/32	3/19
2	black/yellow	signal	1/8	3/16

Crank position sensor (L5)

Device pin	Wire colour	Function	OEM pin	DID1 pin
1	green	signal	1/87	4/26
2	green/white	return	1/88	4/37

Pressure regulator valve (Y74) Connects to output 3

Device pin	Wire colour	Function	OEM pin	DID1 pin	Wire
1	yellow/black	+12V	1/4	4/31	
2	black/yellow	Negative	1/52	4/21	

colours are also known to be red/grey for the 12V feed and black/white for the negative.

Rail pressure sensor (B4/6) Connects to analog in 4

Device pin	Wire colour	Function	OEM pin	DID1 pin
1	grey/brown	return	1/84	4/4
2	green/violet	signal	1/59	4/14
3	red/white	+5V supply	1/86	4/13

Pressure sensor downstream of air cleaner (B28/5) Not necessary, connect to any analog input or omit.

Mass airflow sensor (B2/5) Not necessary, connect to any analog input or omit.

Exhaust back pressure sensor (B60) Not necessary, connect to any analog input or omit.

DPF differential pressure sensor (B28/8) Not necessary, connect to any analog input or omit.

Upstream TWC temperature sensor (B19/7) Not supported.

Downstream TWC temperature sensor (B19/8) Not supported.

Inlet port shutoff motor (M55) Not currently supported, support planned.

Throttle valve actuator (M16/5) Not supported.

O2 sensor upstream (G3/3) Not supported.

Exhaust gas recirculation valve (Y27/9) Not currently supported, support planned.

MAP sensor/charge pressure sensor (B5/1) Connects to analog in 6

Device pin	Wire colour	Function	OEM pin	DID1 pin
1	brown/grey	return	1/83	4/7
2	black/yellow	signal	1/63	4/6
3	red/black	+5V supply	1/60	4/8

Camshaft position sensor (B6/1)

Device pin	Wire colour	Function	OEM pin	DID1 pin
1	brown/green	return	1/14	4/2
2	yellow/grey	signal	1/38	4/3
3	red/violet	+5V supply	1/37	4/12

Coolant temperature sensor (B11/4) Connects to analog in 2

Device pin	Wire colour	Function	OEM pin	DID1 pin
1	brown/red	signal	1/56	4/36
2	green/red	return	1/57	4/27

Charge air temperature sensor (B17/8) Connects to analog in 3

Device pin	Wire colour	Function	OEM pin	DID1 pin
1	brown/violet	signal	1/65	4/23
2	green/white	return	1/34	4/27

Turbocharger VGT actuator (B100/1) Also known as charge air positioner. Connects to PWM output 5.

Device pin	Wire colour	Function	OEM pin	DID1 pin
1	red/black	+12V supply	1/70	3/35
2	brown/blue	ground	1/44	Ground
4	grey/green	PWM control (Output 5)	1/93	3/48

On some engines the positive feed for the turbo actuator is on a thick red/grey wire that is separate to the ECU, and the ground is on a thick brown wire.

Document number: pe07.16-p-2101-99dd
Document title: Wiring diagram for common rail diesel injection (CDI) control unit

Code:	Designation:	Coordinates:
A0	Explanation of color codes	64 L
B11/4	Coolant temperature sensor	48 L
B17/8	Charge air temperature sensor	50 L
B19/7	Upstream TWC [KAT] temperature sensor	28 L
B19/8	Downstream TWC [KAT] temperature sensor	29 L
B2/5	Hot film MAF sensor	21 L
B2/5b1	Intake air temperature sensor	22 L
B28/5	Pressure sensor downstream of air cleaner	19 L
B28/8	Pressure differential sensor (DPF)	27 L
B4/6	Rail pressure sensor	17 L
B40	Oil sensor (oil level, temperature and quality)	11 L
B5/1	Charge pressure sensor	45 L
B50	Fuel temperature sensor	13 L
B6/1	Camshaft Hall sensor	47 L
B60	Exhaust back pressure sensor	24 L
G3/2	O2 sensor 1 upstream TWC [KAT]	36 L
G3/2x1	O2 sensor upstream TWC [KAT] connector	34 K
L5	Crankshaft position sensor	15 L
M16/5	Throttle valve actuator	33 L
M55	Inlet port shutoff motor	31 L
N10/1	Driver-side SAM control module with fuse and relay module	39 L
N3/9	CDI control module	4 A
N3/9	CDI control module	11 A
N3/9	CDI control module	20 A
N3/9	CDI control module	28 A
N3/9	CDI control module	34 A
N3/9	CDI control module	44 A
N3/9	CDI control module	53 A
N3/9	CDI control module	58 A
R39/1	Vent line heater element	12 L
U704	Valid for EURO 4 and USA emissions standards	24 A
W15/3	Ground (electronics)	58 L
X22	Engine compartment and engine connector	57 H
Y100/1	Right charge pressure positioner	52 L
Y100/1	Right charge pressure positioner	55 L
Y27/9	Left exhaust gas recirculation positioner	43 L
Y74	Pressure regulator valve	16 L
Y76	Fuel injectors	3 L
Y76y1	Fuel injector (1st cylinder)	1 L

Document number: pe07.16-p-2101-99dd
Document title: Wiring diagram for common rail diesel injection (CDI) control unit

Code:	Designation:	Coordinates:
Y76y2	Fuel injector (2nd cylinder)	3 L
Y76y3	Fuel injector (3rd cylinder)	4 L
Y76y4	Fuel injector (4th cylinder)	5 L
Y76y5	Fuel injector cylinder 5	7 L
Y76y6	Fuel injector cylinder 6	8 L
Y94	Volume control valve	9 L
Z3/4	Circuit 30 connector sleeve	32 H
Z3/4	Circuit 30 connector sleeve	41 E
Z3/4	Circuit 30 connector sleeve	55 H
Z6/1	Ground connector sleeve	33 G
Z6/1	Ground connector sleeve	43 E
Z6/1	Ground connector sleeve	56 H

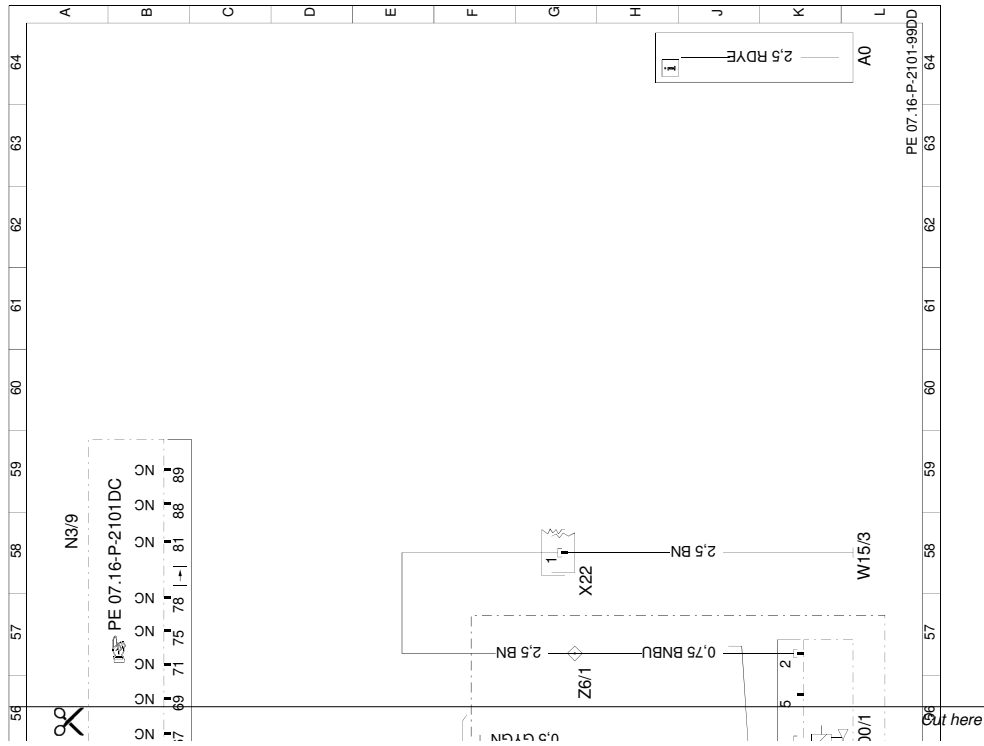

Wiring diagram for common rail diesel injection (CDI) control unit / pe07.16-p-2101-99dd
ENGINE 648 up to 31.5.05 in MODEL 211 Steuergerät N3/9, Blatt 2 / Printed on: 02.01.2020 / Page 4/4

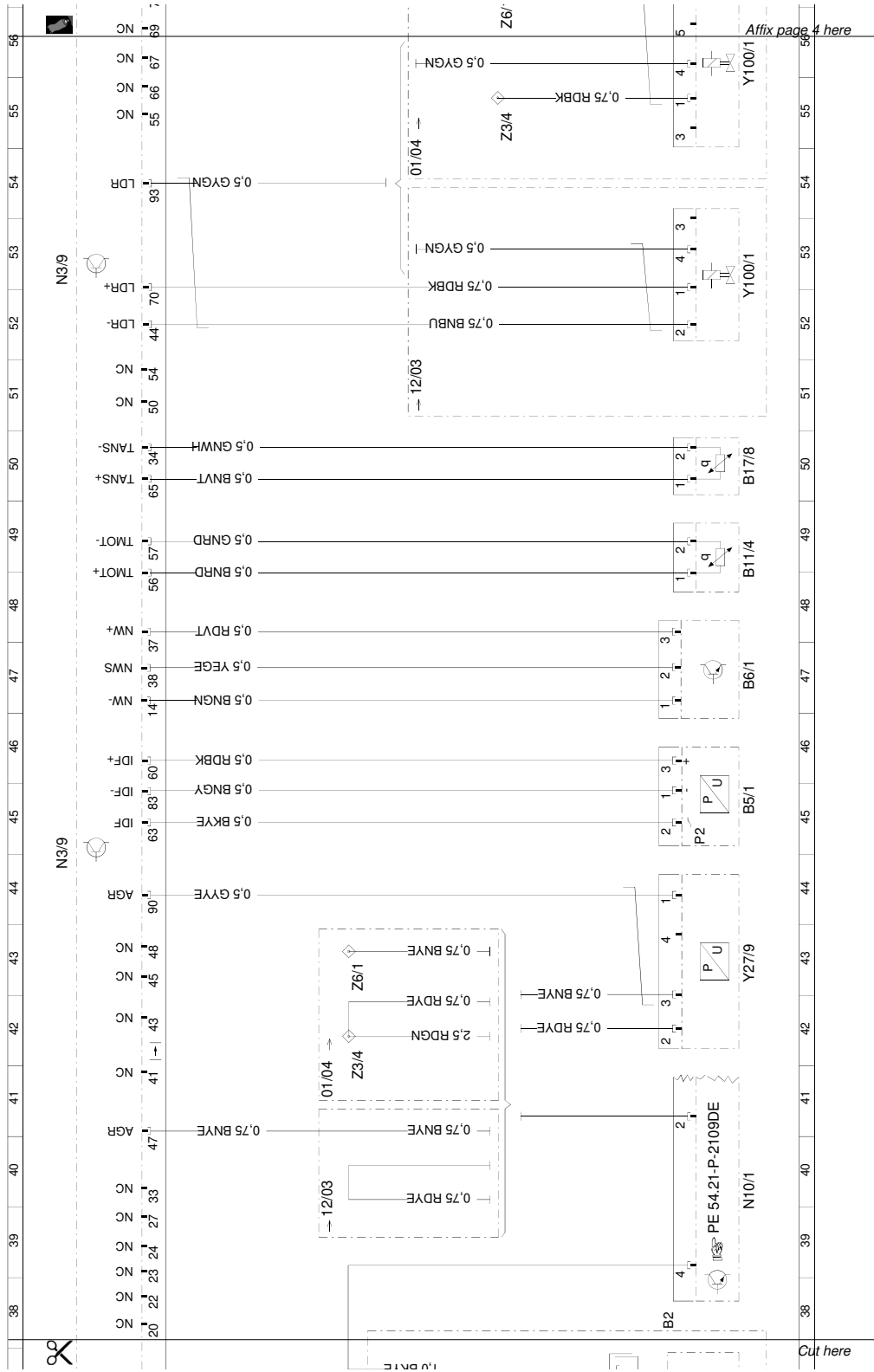

Wiring diagram for common rail diesel injection (CDI) control unit / pe07.16-p-2101-99dd
 ENGINE 648 up to 31.5.05 in MODEL 211 Steuergerät N3/9, Blatt 2 / Printed on: 02.01.2020 / Page 3/4

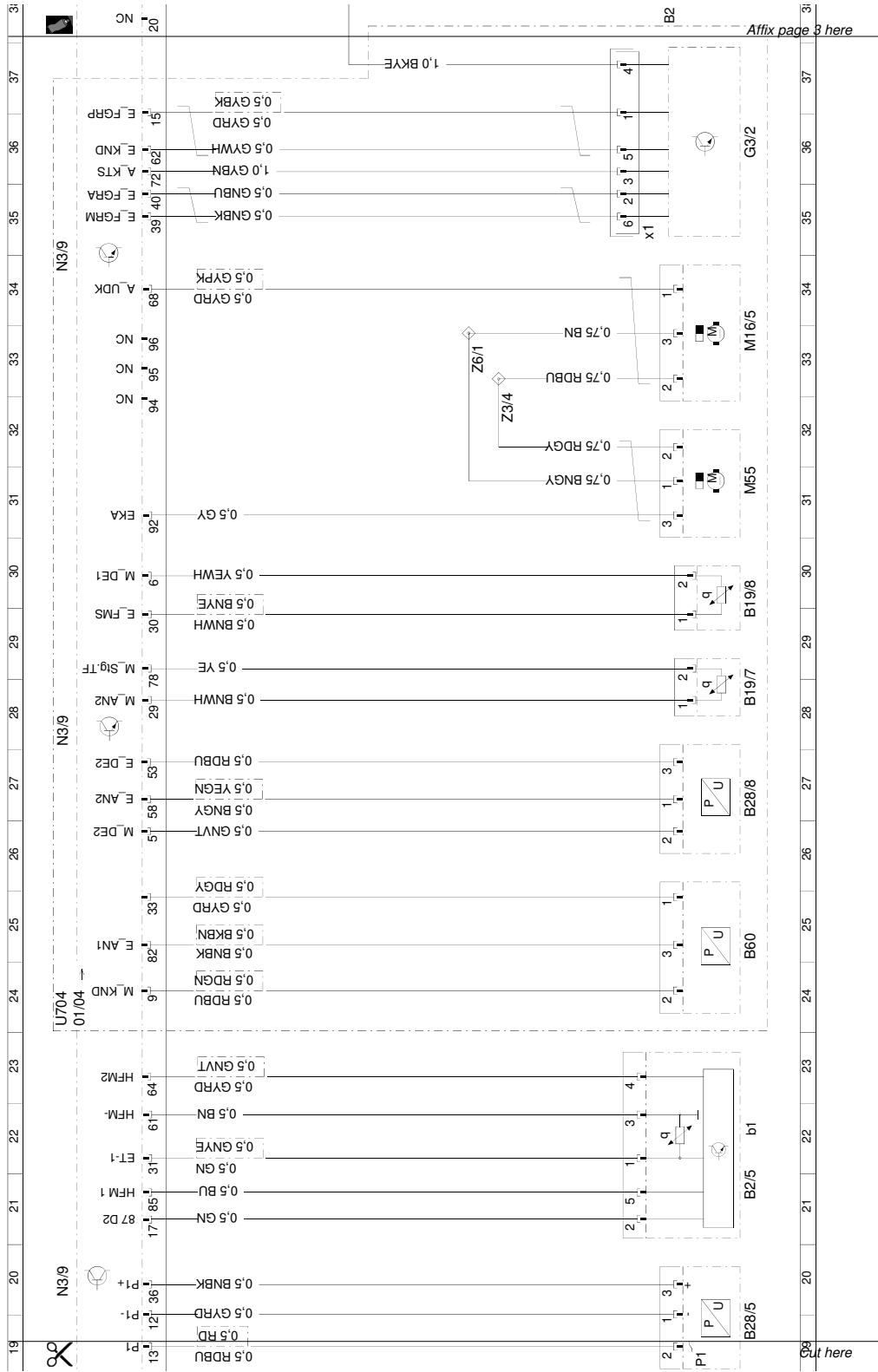

Wiring diagram for common rail diesel injection (CDI) control unit / pe07.16-p-2101-99dd
 ENGINE 648 up to 31.5.05 in MODEL 211 Steuergerät N3/9, Blatt 2 / Printed on: 02.01.2020 / Page 2/4

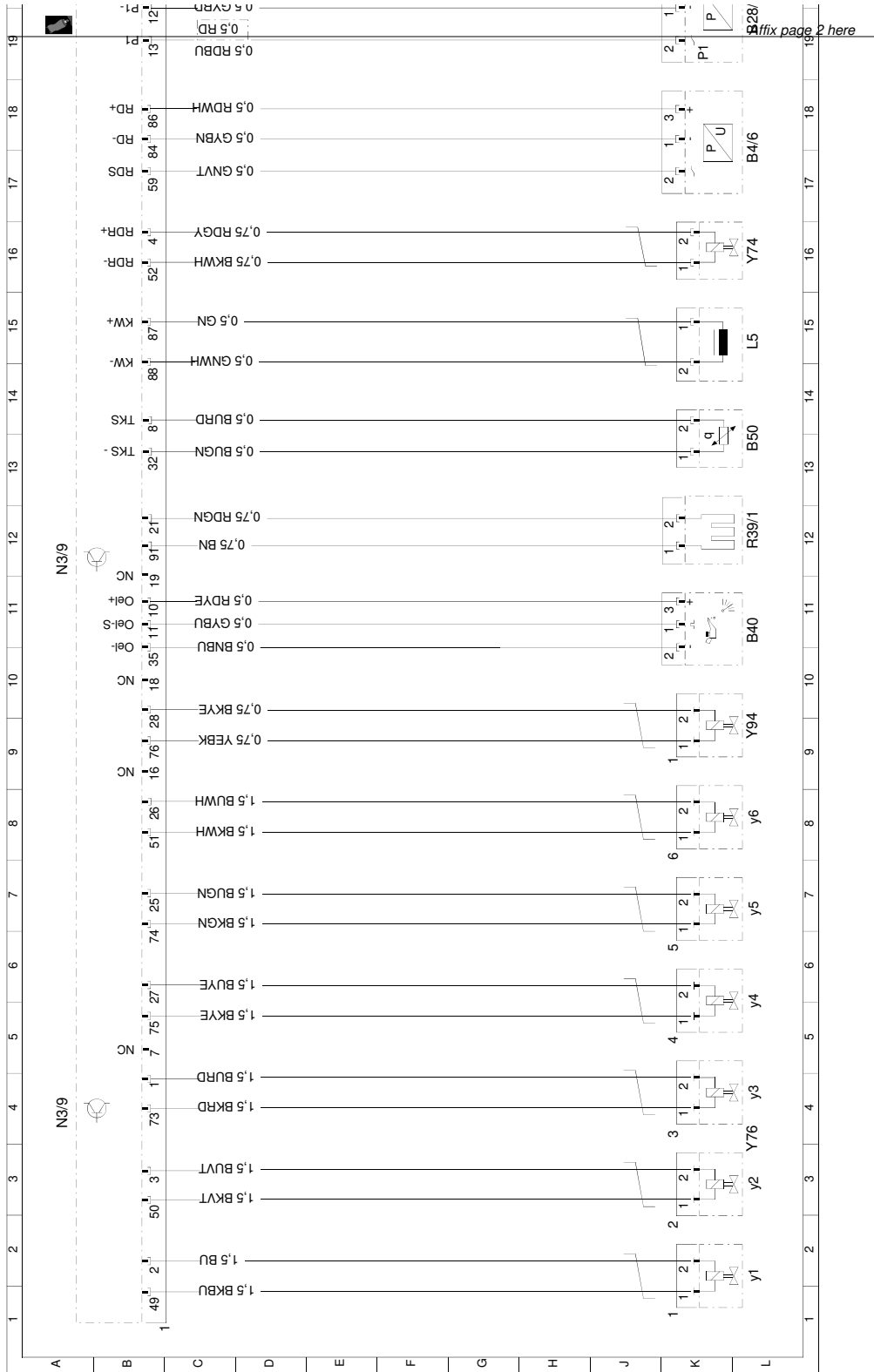

Wiring diagram for common rail diesel injection (CDI) control unit / pe07.16-p-2101-99dd
 ENGINE 648 up to 31.5.05 in MODEL 211 Steuergerät N3/9, Blatt 2 / Printed on: 02.01.2020 / Page 1/4

F.1 W211 chassis side wiring

Power supply

Wire colour	Function	OEM pin	DID1 pin
red/blue	ECU +12V	2/1	1/7
red/green	ECU +12V	2/3	1/8
red/green	Peripheral +12V	2/5	1/1
pink/red	Ignition switch circuit 15	2/19	3/31
brown/yellow	Main relay control	2/44	3/46
brown	Power ground	2/2	1/4
brown	Power ground	2/4	1/5
brown	Power ground	2/6	1/6

Starter relay (N10/1 front SAM)

Device pin	Wire colour	Function	OEM pin	DID1 pin
19/5	brown/pink	Starter relay control negative	2/58	4/33 output 6

Cooling fan (M4/7)

Device pin	Wire colour	Function	OEM pin	DID1 pin
4	green/blue	PWM control signal	2/57	3/52 output 8

Low pressure fuel pump relay (N10/2 rear SAM)

Device pin	Wire colour	Function	OEM pin	DID1 pin
2/7	brown/green	relay control negative	2/55	4/10 output 2

CAN network

Wire colour	Function	OEM pin	DID1 pin
green/white	CAN-C H	2/53	3/1
green	CAN-C L	2/54	3/2

Accelerator pedal (B37)

Device pin	Wire colour	Function	OEM pin	DID1 pin
1	blue/white	+5V supply	2/24	3/5
3	blue	secondary return	2/14	3/23
4	yellow/blue	secondary signal	2/13	3/9
5	violet	primary signal	2/25	3/10
6	blue	primary return	2/26	3/8

Glow plug controller non-USA (N14/2)

Device pin	Wire colour	Function	OEM pin	DID1 pin
1/2	white/green	PWM serial data	2/43	3/25 output 11

Document number: pe07.16-p-2101-99dc
Document title: Wiring diagram of common rail diesel injection (CDI) control unit

Code:	Designation:	Coordinates:
A0	Explanation of color codes	40 L
B37	Accelerator pedal sensor	24 L
B4/1	Left fuel level sensor	18 L
B4/2	Right fuel level sensor	17 L
F32	Front prefuse	10 L
F32	Front prefuse	33 L
F32f69	Fuse 69	33 K
F32f71	Fuse 71	10 K
F34	Interior fuse box	9 L
F34f42	Fuse 42	9 K
M3	Fuel pump (FP)	19 L
M4/7	Electric suction fan engine and AC with integrated control	12 L
N10/1	Driver-side SAM control module with fuse and relay module	6 L
N10/2	Rear SAM control module with fuse and relay module	14 L
N14/2	Preglow output	31 L
N3/9	CDI control module	4 A
N3/9	CDI control module	12 A
N3/9	CDI control module	20 A
N3/9	CDI control module	27 A
R9	Glow plugs	30 E
S40/3	Clutch pedal switch	28 L
U12	Valid for left-hand steering	28 J
U13	Valid for right-hand steering	27 J
U24	Valid for MT [MG]	26 C
W15/1	Ground (right footwell)	26 C
W15/2	Ground (left footwell)	27 C
W15/3	Ground (electronics)	1 E
W6	Ground (left wheelhousing in trunk)	20 E
W9	Ground (at left headlamp unit)	13 G
W9/1	Ground (at left headlamp unit - ignition coil)	29 G
X11/4	Data link connector	2 L
X30/5	Left voltage distributor (CAN) connector	21 L
X36/3	Fuel pump wiring harness connector	16 G
Z6/46	Ground (W15/1) connector sleeve	26 G
Z6/46	Ground (W15/1) connector sleeve	26 E
Z6/47	Ground (W15/2) connector sleeve	27 G
Z6/47	Ground (W15/2) connector sleeve	27 E
Z7/38	Circuit 87 M1i connector sleeve	7 E
Z7/39	Circuit 87 M2i connector sleeve	6 E

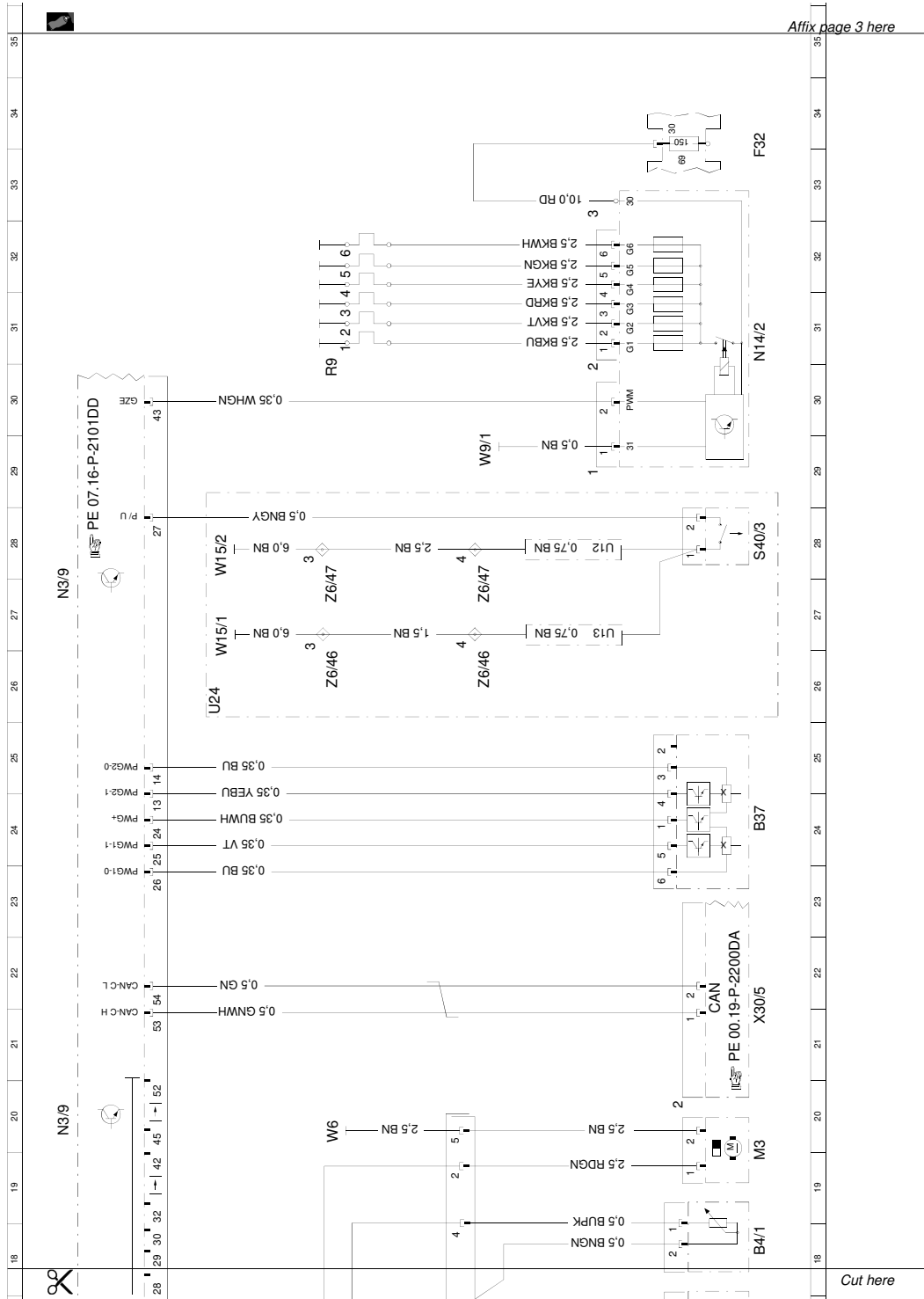

Wiring diagram of common rail diesel injection (CDI) control unit / pe07.16-p-2101-99dc
ENGINE 648 up to 31.5.05 in MODEL 211 Steuergerät N3/9, Blatt 1' / Printed on: 26.08.2021 / Page 2/3

G Mercedes OM646/OM647 wiring

The 646 and 647 wiring is nearly identical to the 648 wiring for all the components that get used apart from the fuel injectors. These diagrams are included to illustrate this, but you can refer to the 648 chapter above for component pin-outs and how they connect to the DID1.

Document number: pe07.16-p-2101-99db
Document title: Wiring diagram for common rail diesel injection (CDI) control unit

Code:	Designation:	Coordinates:
A0	Explanation of color codes	72 L
B11/4	Coolant temperature sensor	61 L
B17/8	Charge air temperature sensor	62 L
B19/7	Upstream TWC [KAT] temperature sensor	35 L
B19/8	Downstream TWC [KAT] temperature sensor	36 L
B2/5	Hot film MAF sensor	27 L
B2/5b1	Intake air temperature sensor	27 L
B28/5	Pressure sensor downstream of air cleaner	24 L
B28/8	Pressure differential sensor (DPF)	31 L
B4/6	Rail pressure sensor	22 L
B40	Oil sensor (oil level, temperature and quality)	16 L
B5/1	Charge pressure sensor	58 L
B50	Fuel temperature sensor	18 L
B6/1	Camshaft Hall sensor	59 L
B60	Exhaust back pressure sensor	33 L
B76	Fuel filter water level sensor	70 L
G2	Generator	48 L
G3/2	O2 sensor 1 upstream TWC [KAT]	42 L
G3/2x1	O2 sensor upstream TWC [KAT] connector	41 K
L5	Crankshaft position sensor	20 L
M16/5	Throttle valve actuator	38 L
M55	Inlet port shutoff motor	51 L
N10/1	Driver-side SAM control module with fuse and relay module	45 L
N3/9	CDI control module	4 A
N3/9	CDI control module	12 A
N3/9	CDI control module	20 A
N3/9	CDI control module	28 A
N3/9	CDI control module	36 A
N3/9	CDI control module	44 A
N3/9	CDI control module	52 A
N3/9	CDI control module	60 A
N3/9	CDI control module	68 A
R39/1	Vent line heater element	17 L
U1	Valid for {{USA}}	69 E
U704	Valid for EURO 4 and USA emissions standards	31 A
U740	Valid for engine 646	1 E
U741	Valid for engine 647	7 E
W15/3	Ground (electronics)	38 D
X22	Engine compartment and engine connector	38 F

Document number: pe07.16-p-2101-99db
Document title: Wiring diagram for common rail diesel injection (CDI) control unit

Code:	Designation:	Coordinates:
Y100/1	Right charge pressure positioner	64 L
Y100/1	Right charge pressure positioner	67 L
Y27/9	Left exhaust gas recirculation positioner	55 L
Y74	Pressure regulator valve	21 L
Y76	Fuel injectors	4 L
Y76	Fuel injectors	10 L
Y76y1	Fuel injector (1st cylinder)	2 L
Y76y1	Fuel injector (1st cylinder)	10 L
Y76y2	Fuel injector (2nd cylinder)	3 L
Y76y2	Fuel injector (2nd cylinder)	8 L
Y76y3	Fuel injector (3rd cylinder)	4 L
Y76y3	Fuel injector (3rd cylinder)	13 L
Y76y4	Fuel injector (4th cylinder)	6 L
Y76y4	Fuel injector (4th cylinder)	9 L
Y76y5	Fuel injector cylinder 5	11 L
Y85	EGR [AGR] cooler bypass flap switchover valve	40 L
Y94	Volume control valve	14 L
Z6/1	Ground connector sleeve	38 G
Z6/1	Ground connector sleeve	50 C
Z6/1	Ground connector sleeve	56 C
Z6/1	Ground connector sleeve	66 G
Z7/41	Sensor supply connector sleeve	30 F
Z7/41	Sensor supply connector sleeve	33 G
Z7/5	Circuit 87 connector sleeve	39 H
Z7/5	Circuit 87 connector sleeve	45 G
Z7/5	Circuit 87 connector sleeve	50 G
Z7/5	Circuit 87 connector sleeve	67 G
Z7/5	Circuit 87 connector sleeve	69 D

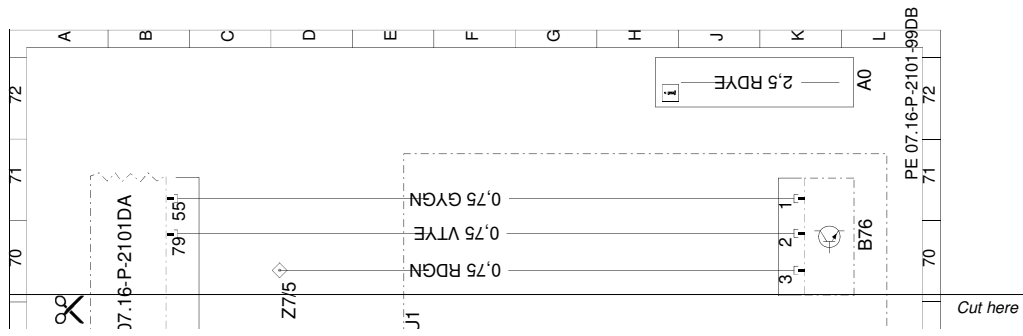

Wiring diagram for common rail diesel injection (CDI) control unit / pe07.16-p-2101-99db
 ENGINE 646 up to 31.5.06, 647 up to 31.5.05 in MODEL 211 Steuergerät N3/9, Blatt 2' / Printed on: 12.05.2022 / Page 5/5

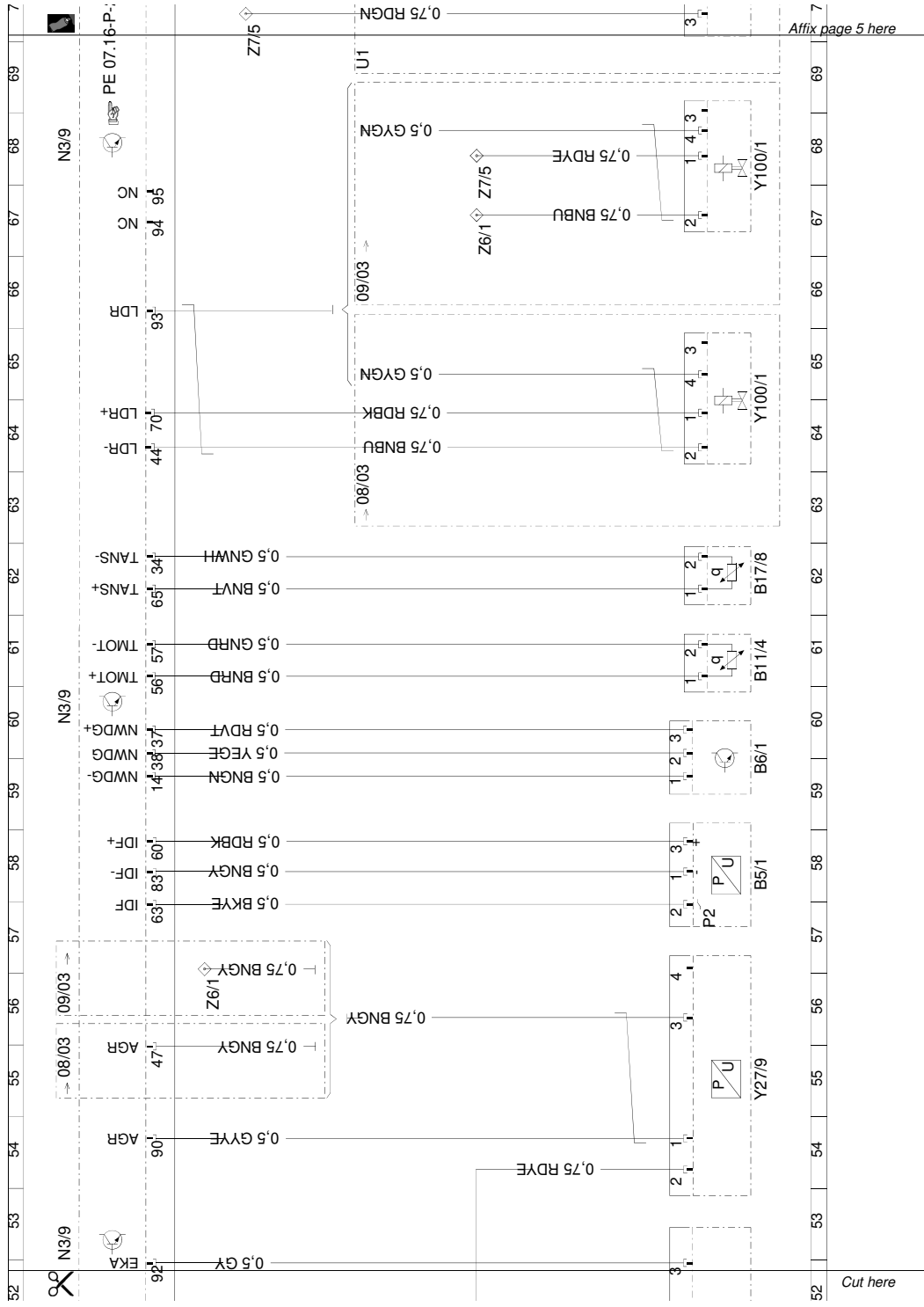

Wiring diagram for common rail diesel injection (CDI) control unit / pe07.16-p-2101-99db
 ENGINE 646 up to 31.5.06, 647 up to 31.5.05 in MODEL 211 Steuergerät N3/9, Blatt 2' / Printed on: 12.05.2022 / Page 4/5

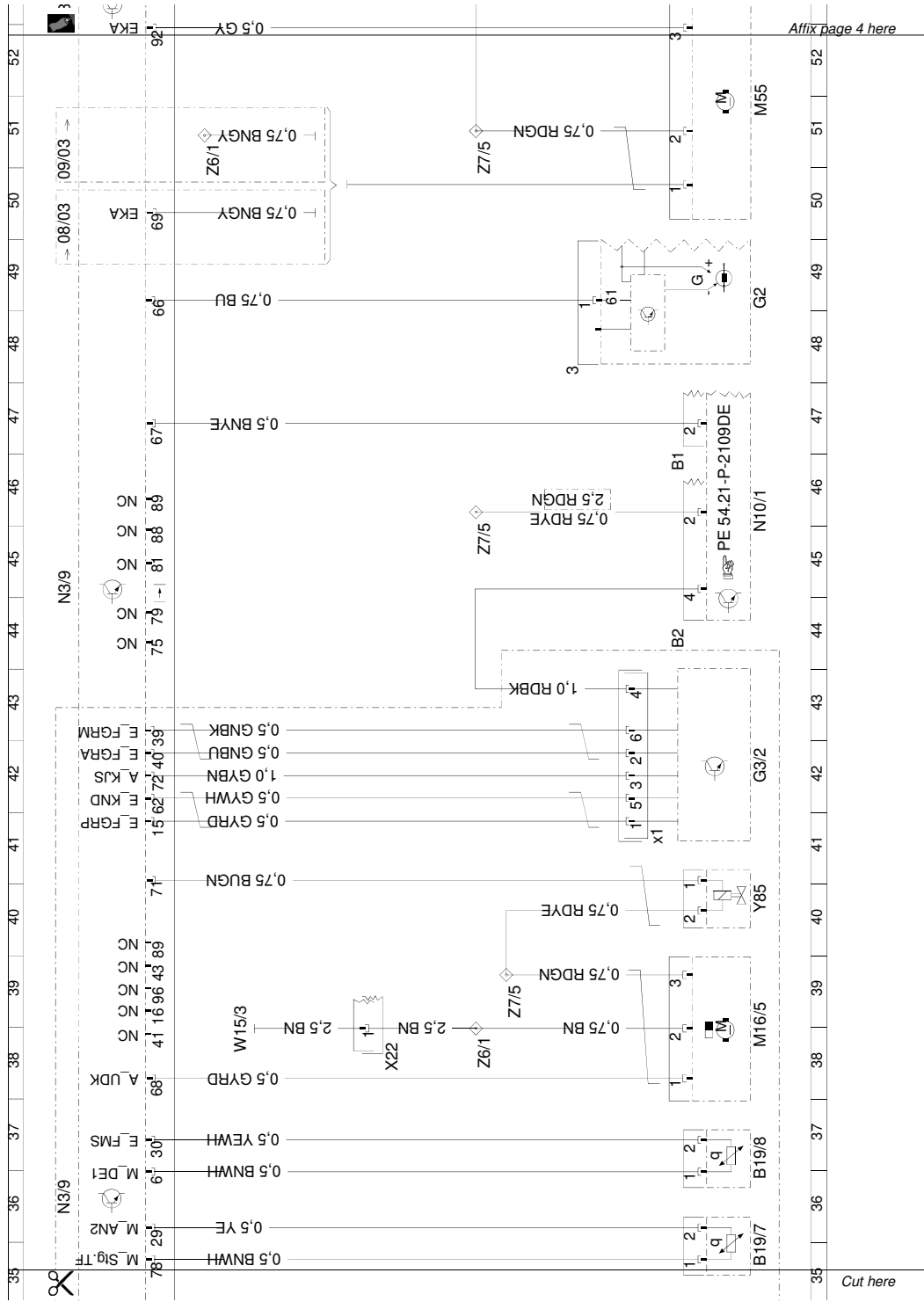

Wiring diagram for common rail diesel injection (CDI) control unit / pe07.16-p-2101-99db
 ENGINE 646 up to 31.5.06, 647 up to 31.5.05 in MODEL 211 Steuergerät N3/9, Blatt 2' / Printed on: 12.05.2022 / Page 3/5

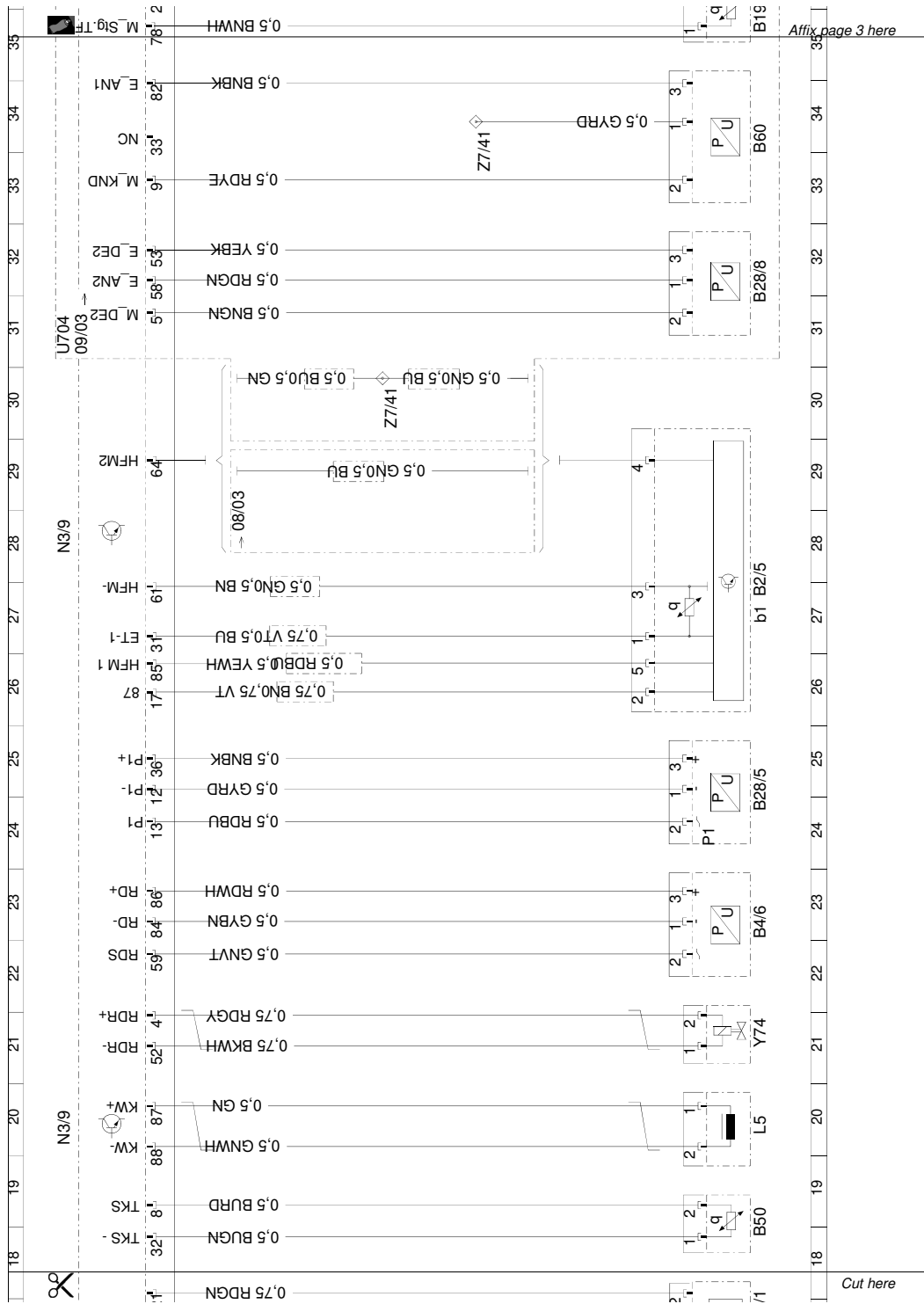

Wiring diagram for common rail diesel injection (CDI) control unit / pe07.16-p-2101-99db
ENGINE 646 up to 31.5.06, 647 up to 31.5.05 in MODEL 211 Steuergerät N3/9, Blatt 2' / Printed on: 12.05.2022 / Page 2/5

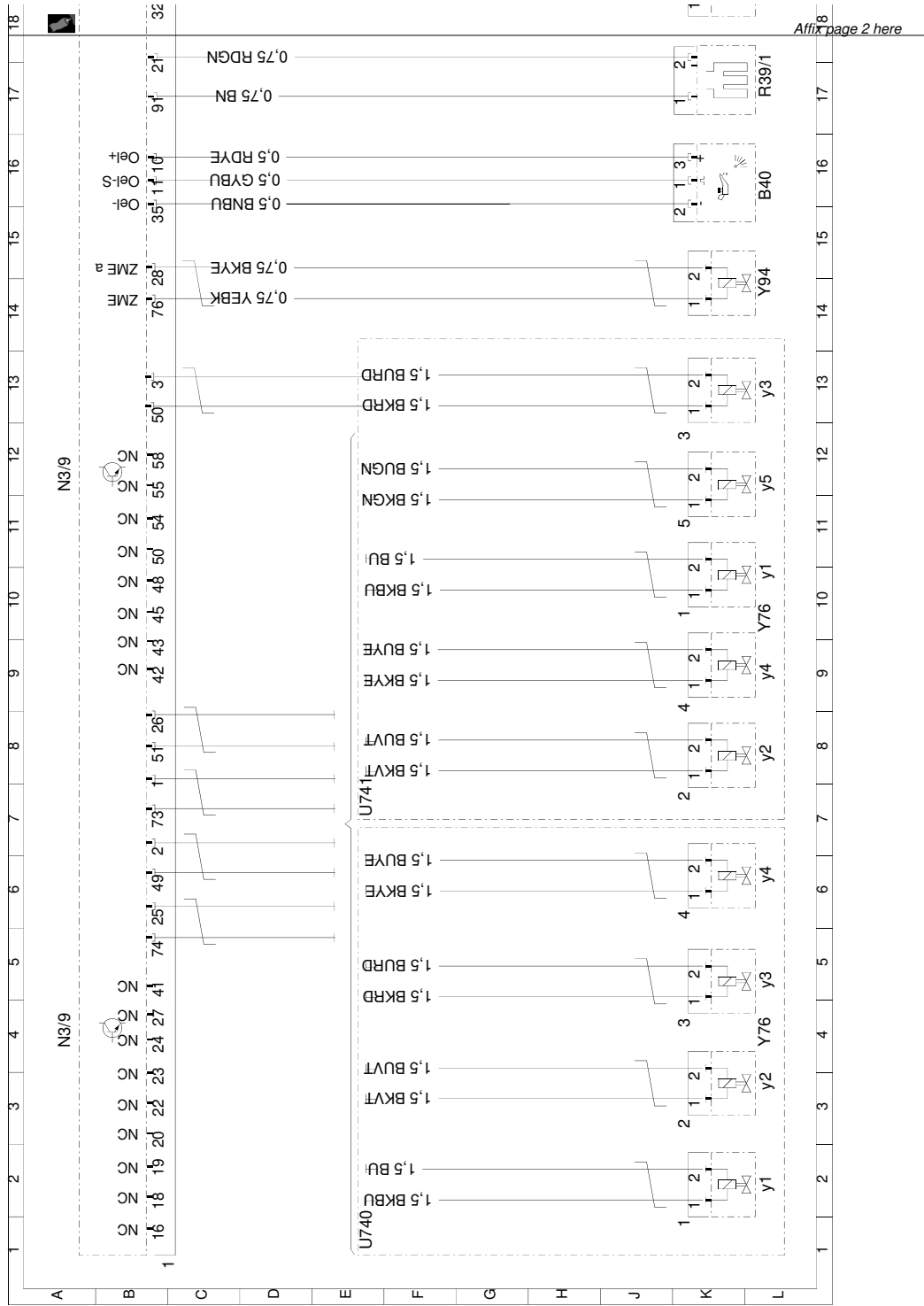

Wiring diagram for common rail diesel injection (CDI) control unit / pe07.16-p-2101-99db
ENGINE 646 up to 31.5.06, 647 up to 31.5.05 in MODEL 211 Steuergerät N3/9, Blatt 2' / Printed on: 12.05.2022 / Page 1/5

Document number: pe07.16-p-2101-99da
Document title: Wiring diagram of common rail diesel injection (CDI) control unit

Code:	Designation:	Coordinates:
A0	Explanation of color codes	40 L
B37	Accelerator pedal sensor	23 L
B4/1	Left fuel level sensor	17 L
B4/2	Right fuel level sensor	16 L
F32	Front prefuse	8 L
F32	Front prefuse	35 L
F32f69	Fuse 69	35 K
F32f71	Fuse 71	8 K
F34	Interior fuse box	2 L
F34f42	Fuse 42	1 K
M3	Fuel pump (FP)	18 L
M4/7	Electric suction fan engine and AC with integrated control	10 L
N10/1	Driver-side SAM control module with fuse and relay module	5 L
N10/2	Rear SAM control module with fuse and relay module	13 L
N14/2	Preglow output	33 L
N3/9	CDI control module	4 A
N3/9	CDI control module	12 A
N3/9	CDI control module	20 A
N3/9	CDI control module	28 A
R9	Glow plugs	32 E
S16/6	Kickdown switch	26 L
S40/3	Clutch pedal switch	29 L
U12	Valid for left-hand steering	27 J
U12	Valid for left-hand steering	30 J
U13	Valid for right-hand steering	28 J
U13	Valid for right-hand steering	29 J
U24	Valid for MT [MG]	25 C
U740	Valid for engine 646	11 G
U741	Valid for engine 647	11 G
U741	Valid for engine 647	34 H
U791	The electrical switching contact of the kickdown switch (S16/6) is being discontinued. Its function is being assumed by the accelerator pedal sensor (B37).	25 G
W15/1	Ground (right footwell)	27 D
W15/2	Ground (left footwell)	29 D
W15/3	Ground (electronics)	1 E
W6	Ground (left wheelhousing in trunk)	19 E
W9	Ground (at left headlamp unit)	11 H
W9	Ground (at left headlamp unit)	12 H
W9/1	Ground (at left headlamp unit - ignition coil)	31 H
X11/4	Data link connector	4 H

Document number: pe07.16-p-2101-99da
Document title: Wiring diagram of common rail diesel injection (CDI) control unit

Code:	Designation:	Coordinates:
X30/5	Left voltage distributor (CAN) connector	20 L
X36/3	Fuel pump wiring harness connector	15 H
Z6/46	Ground (W15/1) connector sleeve	27 H
Z6/46	Ground (W15/1) connector sleeve	27 F
Z6/47	Ground (W15/2) connector sleeve	26 H
Z6/47	Ground (W15/2) connector sleeve	29 H
Z6/47	Ground (W15/2) connector sleeve	29 F
Z92	TNA-signal connector sleeve	2 E

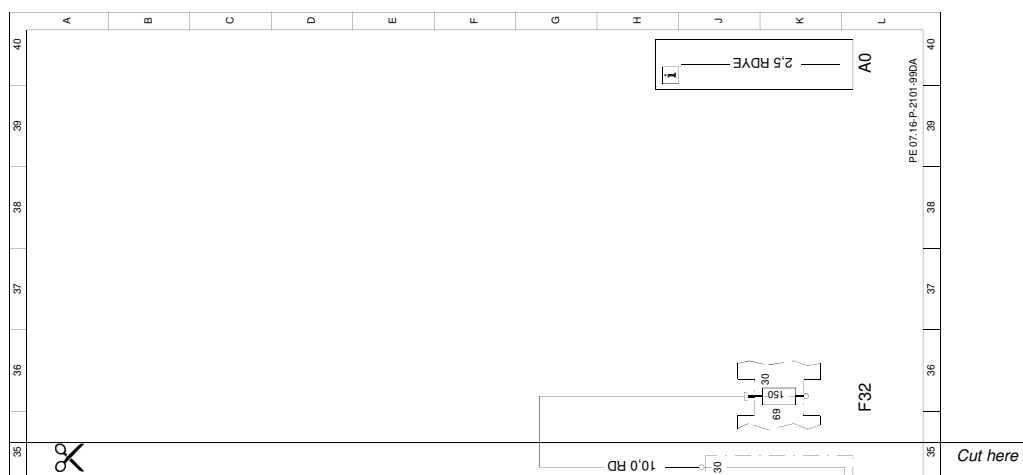

Wiring diagram of common rail diesel injection (CDI) control unit / pe07.16-p-2101-99da
ENGINE 646 up to 31.5.06, 647 up to 31.5.05 in MODEL 211 Steuergerät N3/9, Blatt 1' / Printed on: 12.05.2022 / Page 3/3

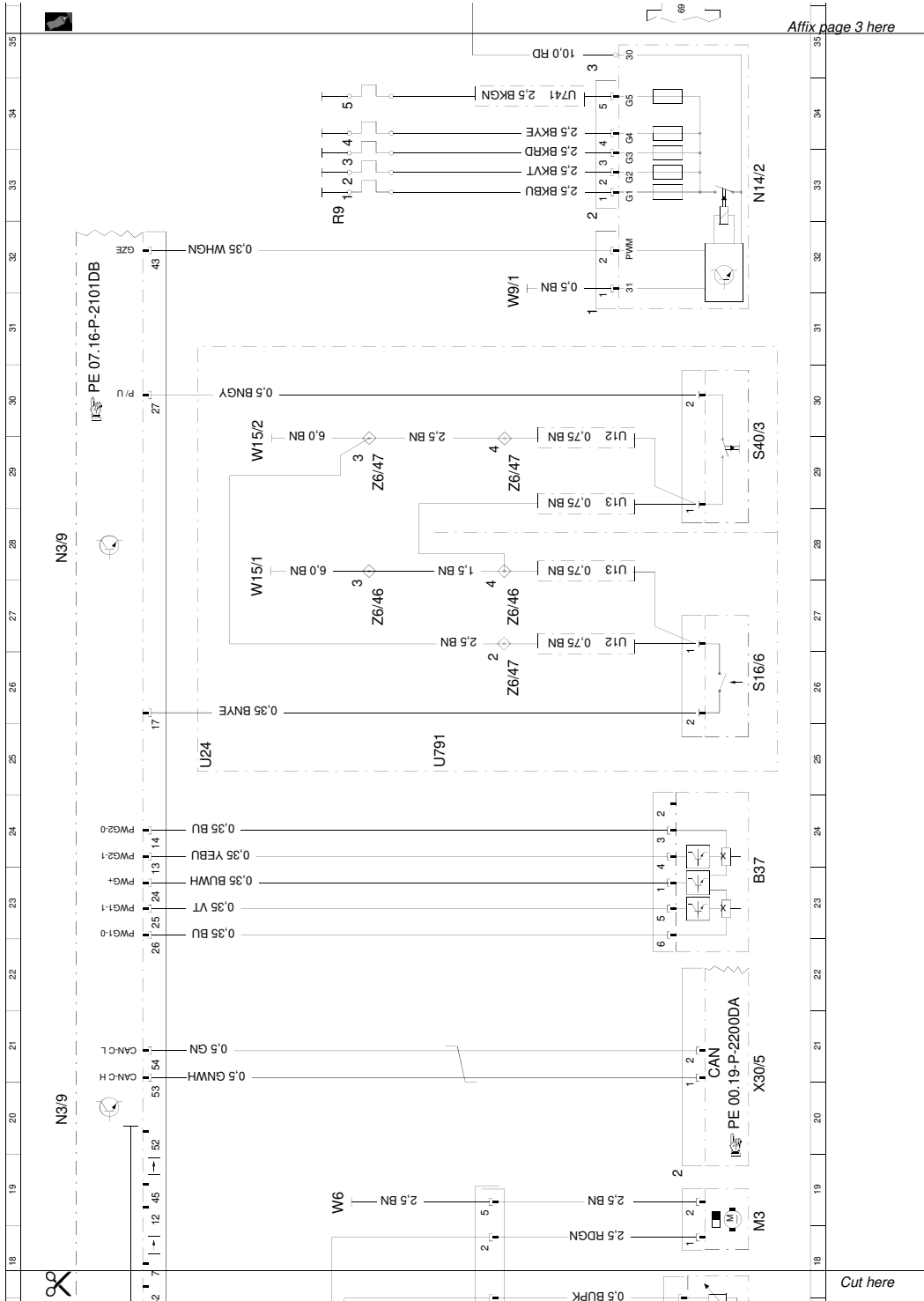

Affix page 3 here

Cut here

Wiring diagram of common rail diesel injection (CDI) control unit / pe07.16-p-2101-99da
ENGINE 646 up to 31.5.06, 647 up to 31.5.05 in MODEL 211 Steuergerät N3/9, Blatt 1' / Printed on: 12.05.2022 / Page 2/3

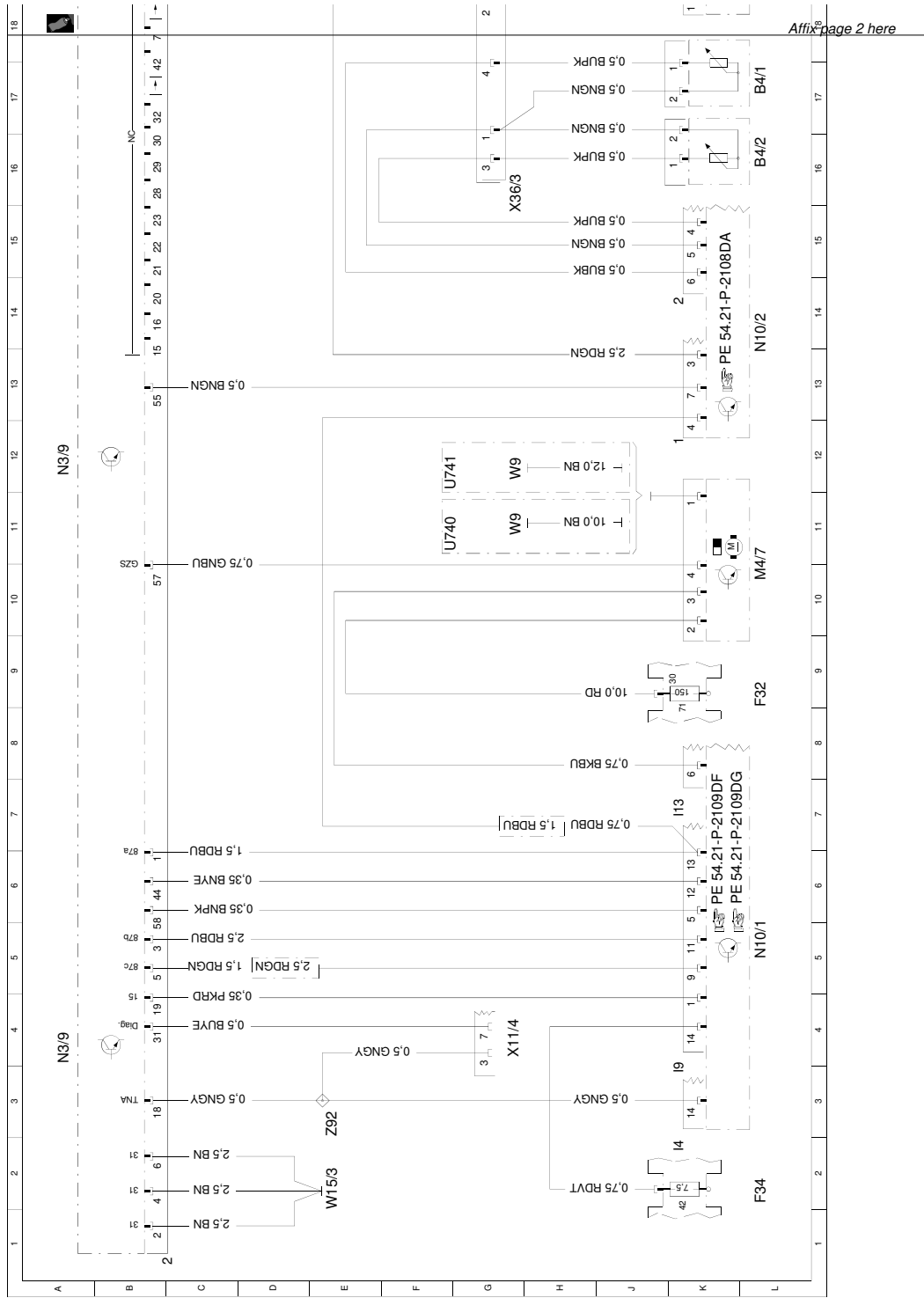

Affix page 2 here

Wiring diagram of common rail diesel injection (CDI) control unit / pe07.16-p-2101-99da
 ENGINE 646 up to 31.5.06, 647 up to 31.5.05 in MODEL 211 Steuergerät N3/9, Blatt 1' / Printed on: 12.05.2022 / Page 1/3

H Mercedes OM628 wiring

This chapter covers the Mercedes Benz OM628 engine as found in the ML400 CDI and S400 CDI.

H.1 Wiring of engine devices

Fuel injectors 1-8 (Y76/y1-Y76/y8)

Device pin	Wire colour	Function	OEM pin	DID1 pin
y1/1	black/blue	Injector 1 negative	F13	5/5
y2/1	black/violet	Injector 2 negative	F1	5/8
y3/1	black/red	Injector 3 negative	F15	5/7
y4/1	black/yellow	Injector 4 negative	F7	5/6
y5/1	black/green	Injector 5 negative	F9	5/9
y6/1	black/white	Injector 6 negative	F21	5/3
y7/1	grey/blue	Injector 7 negative	F19	5/2
y8/1	black	Injector 8 negative	F17	5/1
	blue	Injectors 2,3,5,8 positive	F3	5/4
	blue	Injectors 1,4,6,7 positive	F5	5/4

Crank trigger (L5)

Device pin	Wire colour	Function	OEM pin	DID1 pin
1	green/white	return	E34	4/37
2	green	signal	E33	4/26

Cam position sensor (B6/1)

Device pin	Wire colour	Function	OEM pin	DID1 pin
1	brown/green	return	E22	4/2
2	yellow/green	signal	E45	4/3
3	red/blue	+5V supply	E46	4/12

Oil level sensor (B40) Optional. Connects to any digital input capable of frequency input (input 1, 3, 4, 5, or on controllers with serial number 200 and up inputs 6 and 7 can also be used)
Suggested wiring for controllers with serial numbers from 200 and up:

Device pin	Wire colour	Function	OEM pin	DID1 pin
1	grey/blue	signal	E28	4/15 digital in 6
2	brown/black	return	E1	4/17
3	red/yellow	+5V	E40	4/18

Suggested wiring for older controllers:

Device pin	Wire colour	Function	OEM pin	DID1 pin
1	grey/blue	signal	E28	3/22 digital in 3
2	brown/black	return	E1	3/41
3	red/yellow	+5V	E40	3/40

Rail pressure sensor (B4/6)

Device pin	Wire colour	Function	OEM pin	DID1 pin
1	brown/yellow	return	E14	4/4
2	green/yellow	signal	E26	4/14 analog in 4
3	red/green	+5V supply	E37	4/13

Charge air temperature sensor (B17)

Device pin	Wire colour	Function	OEM pin	DID1 pin
1	brown/white	return	E7	4/27
2	green/white	signal	E19	4/23 analog in 3

Engine coolant temperature sensor (B11/4)

W211 and W463 wiring:

Device pin	Wire colour	Function	OEM pin	DID1 pin
1	brown/white	return	E18	4/27
2	green/red	signal	E30	4/36 analog in 2

W163 wiring:

Device pin	Wire colour	Function	OEM pin	DID1 pin
1	brown/white	return	E48	4/27
2	green/red	signal	E35	4/36 analog in 2

Mass air flow sensors (B2/6 and B2/7) Not supported, no connection required.

EGR actuators (Y27/9 and Y27/10) Not supported, no connection required.

Left hand side VGT actuator (Y100)

Device pin	Wire colour	Function	OEM pin	DID1 pin
1	grey/green	+12V supply	E48	3/35
2	brown/white	ground	E5/E9	3/19
3	no connection			
4	red/green	PWM control signal	E23	3/48 output 5

Right hand side VGT actuator (Y100/1)

Device pin	Wire colour	Function	OEM pin	DID1 pin
1	grey/yellow	+12V supply	E47	3/30
2	brown/green	ground	E5/E9	3/19
3	no connection			
4	red/yellow	PWM control signal	E6	3/51 output 7

Manifold absolute pressure sensor (B28)

Device pin	Wire colour	Function	OEM pin	DID1 pin
1	brown/grey	return	E20	4/7
2	black/yellow	signal	E41	4/6 analog in 6
3	red/black	+5V supply	E25	4/8

Glow control module (N14/2)

Located above alternator.

Device pin	Wire colour	Function	OEM pin	DID1 pin
1	white	Control signal	E43	3/25

Pressure regulator valve (Y74)

Located on rear of central fuel rail.

Device pin	Wire colour	Function	OEM pin	DID1 pin
1	black/white	negative	F12	4/21 output 3
2	red/black	+12V supply	F16	4/31

Volume control valve (Y94)

Located on high pressure fuel pump, round metal cylinder with 2 pin connector on the side.

Device pin	Wire colour	Function	OEM pin	DID1 pin
1	brown/black	negative	F8	3/50 output 4
2	red/black	+12V supply	F2	3/37

H.2 OEM chassis side wiring

Note that the wire colours are specified for W220. Some differences in colours may exist in W211 or W463 but the pins will be the same.

Power supply

Wire colour W220	Colour W163	Function	OEM pin	DID1 pin
red/blue	green	ECU +12V	B3	1/7
red/blue	green	ECU +12V	B4	1/8
red/green	green	Peripheral +12V	A4	1/1
pink/red	white	Ignition switch circuit 15	D6	3/31
red/green	pink	Main relay control	B2	3/46
brown	brown	Power ground	A1	1/4
brown	brown	Power ground	A2	1/5
brown	brown	Power ground	A5	1/6

CAN network

Wire colour	Function	OEM pin	DID1 pin
green/white	CAN-C H	D4	3/1
green	CAN-C L	D17	3/2

Accelerator pedal (B37)

Device pin	Wire colour	Function	OEM pin	DID1 pin
1	blue/green	+5V supply	D8	3/5
3	blue/grey	secondary return	D3	3/23
4	violet/yellow	secondary signal	D2	3/9
5	violet/green	primary signal	D7	3/10
6	brown/white	primary return	D13	3/8

Accelerator pedal on W463 (R25)

Also applies for W163, where the pedal is component B37.

Device pin	Wire colour	Function	OEM pin	DID1 pin
1	blue/brown	+5V supply	C35	3/5
3	brown/white	secondary return	C17	3/23
4	violet/yellow	secondary signal	C7	3/9
5	violet/green	primary signal	C27	3/10
6	brown/yellow	primary return	C16	3/8

Starter relay (K40/7 fuse/relay module)

Device pin	Wire colour	Colour W163	Function	OEM pin	DID1 pin
I3/2	blue/red	grey	Starter relay control negative	C6	4/33 output 6

Low pressure fuel pump relay (K40/5kT) W220

Device pin	Wire colour	Function	OEM pin	DID1 pin
K40/5 I1/13	red/blue	+12V supply	D24	4/11
K40/5 I1/14	grey/black	relay control negative	D23	4/10 output 2

Low pressure fuel pump relay (F1k3) W163

Device pin	Wire colour	Function	OEM pin	DID1 pin
k3/1	pink	+12V supply	C1	4/11
k3/2	white	relay control negative	C11	4/10 output 2

Glow plug controller (N14/2)

Device pin	Wire colour	Function	OEM pin	DID1 pin
2/1	white	PWM serial data	E43	3/25 output 11

Cooling fan (M4/7)

Device pin	Wire colour	Function	OEM pin	DID1 pin
4	yellow/blue	PWM control signal	A6	3/52 output 8

Heater booster (N33/2)

Device pin	Wire colour	Function	OEM pin	DID1 pin
2/2	red/yellow	PWM control signal	F6	3/49 output 1

Charge air cooler pump (M44)

Device pin	Wire colour	Function	OEM pin	DID1 pin
2	blue/white	Ground	A8	3/19

This configuration will run the pump whenever ignition is switched on. Alternatively it may be connected to any 5 amp output eg pin 3/12 output 9.

H.3 Factory diagrams W220 S400CDI

Document number: pe07.16-p-2101-99sd
Document title: Wiring diagram of common rail diesel injection (CDI) control module

Code:	Designation:	Coordinates:
A6	STH or HB heater unit	46 L
B11/4	Coolant temperature sensor	19 L
B17	Intake air temperature sensor	18 L
B2/6	Left hot film MAF sensor	32 L
B2/7	Right hot film MAF sensor	36 L
B28	Pressure sensor	38 L
B4/6	Rail pressure sensor	16 L
B40	Oil sensor (oil level, temperature and quality)	20 L
B6/1	Camshaft Hall sensor	21 L
L5	Crankshaft position sensor	23 L
M16/5	Throttle valve actuator	15 L
N3/9	CDI control module	4 A
N3/9	CDI control module	12 A
N3/9	CDI control module	19 A
N3/9	CDI control module	27 A
N3/9	CDI control module	36 A
N3/9	CDI control module	41 A
W50/3	Ground shielding, CAN STH telestart	43 H
X30/4	Right voltage distributor (CAN) connector	44 A
X30/4	Right voltage distributor (CAN) connector	48 A
Y100	Left charge pressure positioner	28 L
Y100/1	Right charge pressure positioner	30 L
Y27/10	Right exhaust gas recirculation positioner	24 L
Y27/9	Left exhaust gas recirculation positioner	26 L
Y74	Pressure regulator valve	12 L
Y76	Fuel injectors	4 L
Y76	Fuel injectors	9 L
Y76y1	Fuel injector (1st cylinder)	2 L
Y76y2	Fuel injector (2nd cylinder)	9 L
Y76y3	Fuel injector (3rd cylinder)	8 L
Y76y4	Fuel injector (4th cylinder)	4 L
Y76y5	Fuel injector cylinder 5	7 L
Y76y6	Fuel injector cylinder 6	3 L
Y76y7	Fuel injector cylinder 7	5 L
Y76y8	Fuel injector cylinder 8	10 L
Y83	Intake port shutoff switchover valve	13 L
Y94	Volume control valve	14 L
Z20/20	Cable end not insulated, placed inside insulated tubing	43 D
Z6/18	Electronics ground connector sleeve	16 H

Document number: pe07.16-p-2101-99sd
Document title: Wiring diagram of common rail diesel injection (CDI) control module

Code:	Designation:	Coordinates:
Z6/18	Electronics ground connector sleeve	19 H
Z6/18	Electronics ground connector sleeve	32 H
Z6/18	Electronics ground connector sleeve	36 H
Z6/30	Circuit 31 connector sleeve	27 H
Z6/30	Circuit 31 connector sleeve	29 H
Z6/30	Circuit 31 connector sleeve	33 H
Z6/30	Circuit 31 connector sleeve	36 H
Z73/4	CAN bus Telestart STH screening connector sleeve	43 G
Z99/6	Common rail solenoid valve 1 connector sleeve	2 H
Z99/7	Common rail solenoid valve 2 connector sleeve	7 H

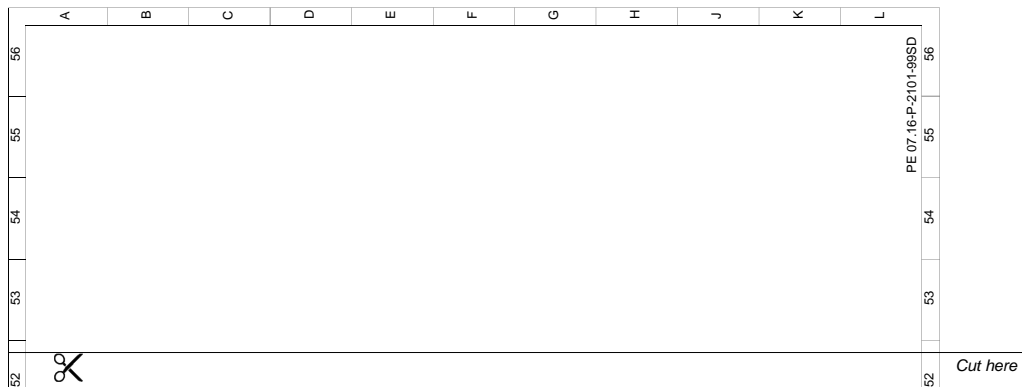

Wiring diagram of common rail diesel injection (CDI) control module / pe07.16-p-2101-99sd
ENGINE 628 in MODEL 220 control module n3/9, sheet 2 / Printed on: 17.02.2019 / Page 4/4

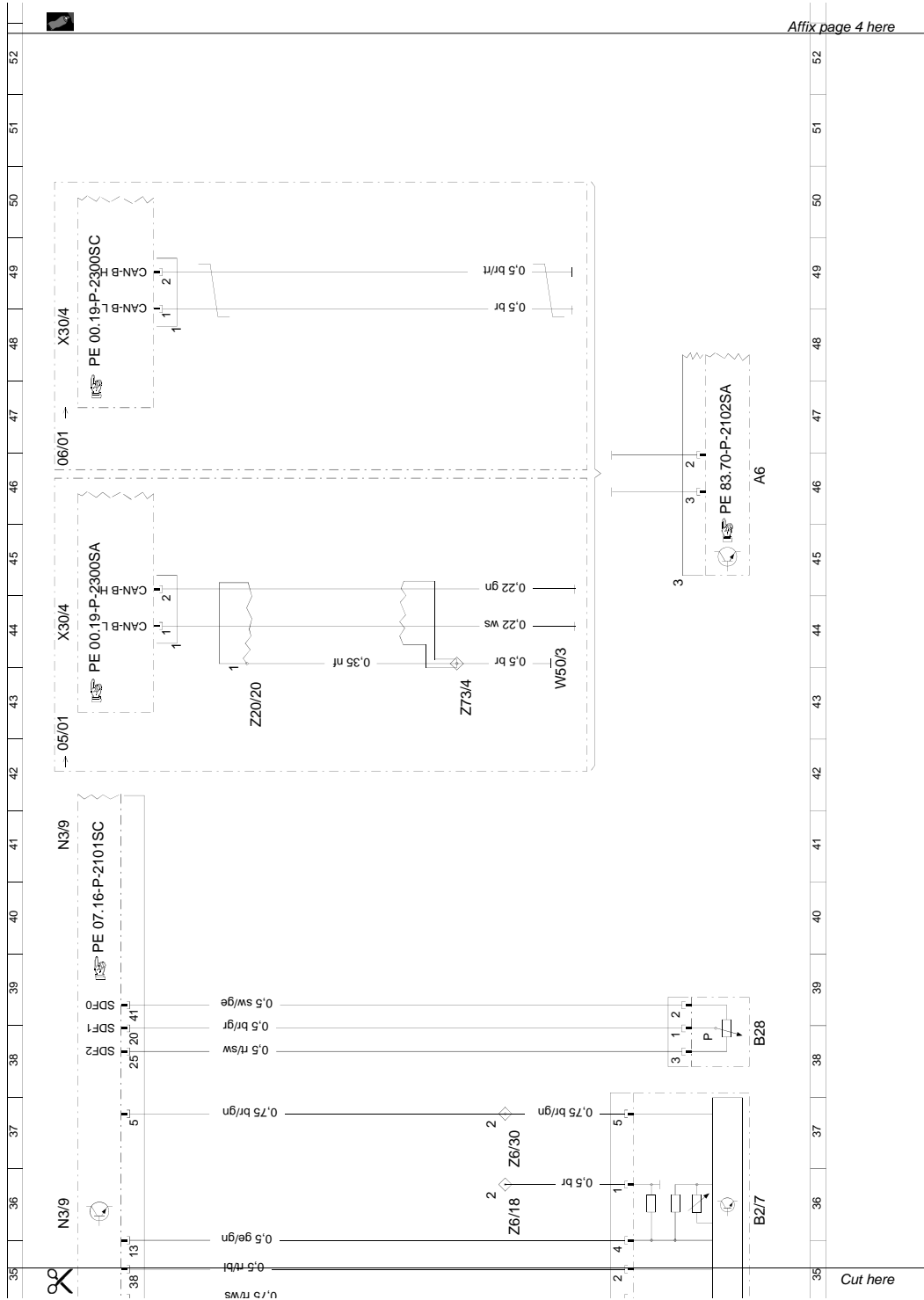

Wiring diagram of common rail diesel injection (CDI) control module / pe07.16-p-2101-99sd
 ENGINE 628 in MODEL 220 control module n3/9, sheet 2 / Printed on: 17.02.2019 / Page 3/4

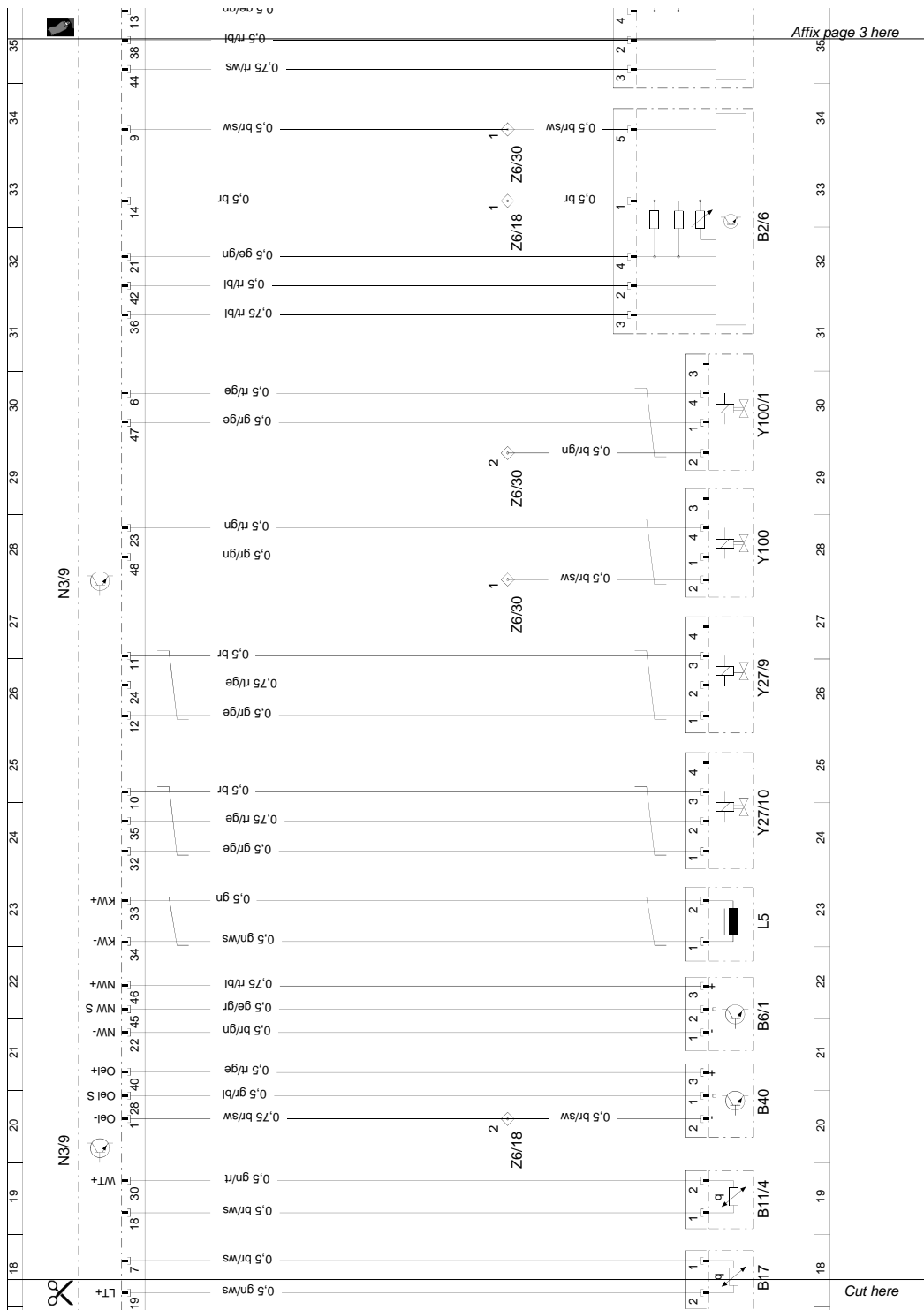

Wiring diagram of common rail diesel injection (CDI) control module / pe07.16-p-2101-99sd
ENGINE 628 in MODEL 220 control module n3/9, sheet 2 / Printed on: 17.02.2019 / Page 2/4

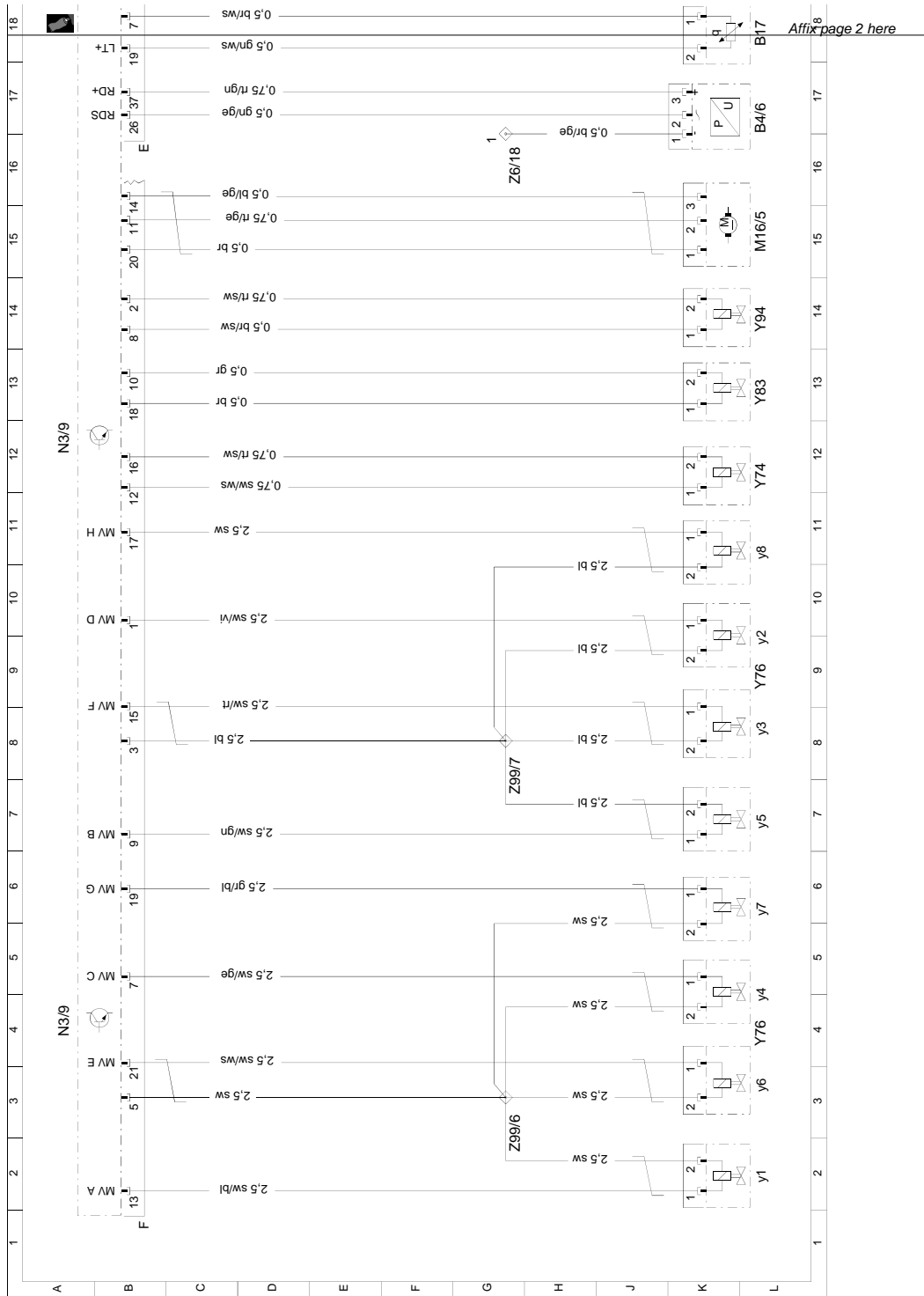

Wiring diagram of common rail diesel injection (CDI) control module / pe07.16-p-2101-99sd
ENGINE 628 in MODEL 220 control module n3/9, sheet 2 / Printed on: 17.02.2019 / Page 1/4

Document number: pe07.16-p-2101-99sc
Document title: Wiring diagram of common rail diesel injection (CDI) control module

Code:	Designation:	Coordinates:
B37	Accelerator pedal sensor	56 L
F1/1	Right fuse box	2 L
F1/1	Right fuse box	16 L
F1/1	Right fuse box	50 L
F1/1f43	Fuse 43	2 K
F1/1f43	Fuse 43	16 K
F1/1f44	Fuse 44	3 K
F1/1f44	Fuse 44	17 K
F1/1f47	Fuse 47	50 K
G1	Battery	34 L
G2	Generator	42 L
K40/5	Rear fuse and relay module	61 L
K40/5f52	Fuse 52	58 L
K40/5kT	Fuel pump relay module	60 L
K40/6	Left front fuse and relay module	68 L
K40/7	Right front fuse and relay module	7 L
K40/7	Right front fuse and relay module	21 L
K40/7	Right front fuse and relay module	45 L
M1	Starter	33 L
M3	Fuel pump (FP)	62 L
M4/7	Electric suction fan engine and AC with integrated control	48 L
M44	Charge air cooler circulation pump	53 L
N14/2	Preglow output	27 L
N2/7	Restraint systems control module	71 L
N3/9	CDI control module	4 A
N3/9	CDI control module	10 A
N3/9	CDI control module	20 A
N3/9	CDI control module	27 A
N3/9	CDI control module	36 A
N3/9	CDI control module	44 A
N3/9	CDI control module	52 A
N3/9	CDI control module	61 A
N3/9	CDI control module	69 A
N3/9	CDI control module	74 A
N33/2	Heater booster control module	31 L
N73	DI control module	12 L
R9	Glow plugs	26 E
S16/6	Kickdown switch	74 L
W10	Ground (battery)	34 H

Document number: pe07.16-p-2101-99sc
Document title: Wiring diagram of common rail diesel injection (CDI) control module

Code:	Designation:	Coordinates:
W16/4	Ground (output ground - component compartment - right)	25 E
W16/6	Electronics ground (right of component compartment)	7 H
W16/6	Electronics ground (right of component compartment)	21 H
W16/6	Electronics ground (right of component compartment)	49 E
W17/1	Ground (left rear seat)	62 H
W3/7	Ground (bottom of left wheelhousing)	48 H
X11/4	Data link connector	8 H
X11/4	Data link connector	22 F
X35/66	Compact wiring harness and diagnostic module 2 separation point, cockpit	22 H
X4/10	Terminal block and fuse box (circuit 30 and 61)	37 L
X4/10f1	Fuse 1	37 K
X4/10f2	Fuse 2	37 K
X4/10f3	Fuse 3	38 K
Z3	Circuit 15 connector sleeve	67 E
Z37/2	CAN engine bus (low) connector sleeve	64 J
Z37/3	CAN engine bus (high) connector sleeve	63 J
Z5/1	Blower connector sleeve	51 E
Z7/47	Circuit 87D1 connector sleeve	15 H
Z7/47	Circuit 87D1 connector sleeve	18 H
Z7/48	Circuit 87D2 connector sleeve	3 H
Z7/48	Circuit 87D2 connector sleeve	16 H
Z7/48	Circuit 87D2 connector sleeve	49 H
Z7/48	Circuit 87D2 connector sleeve	53 E

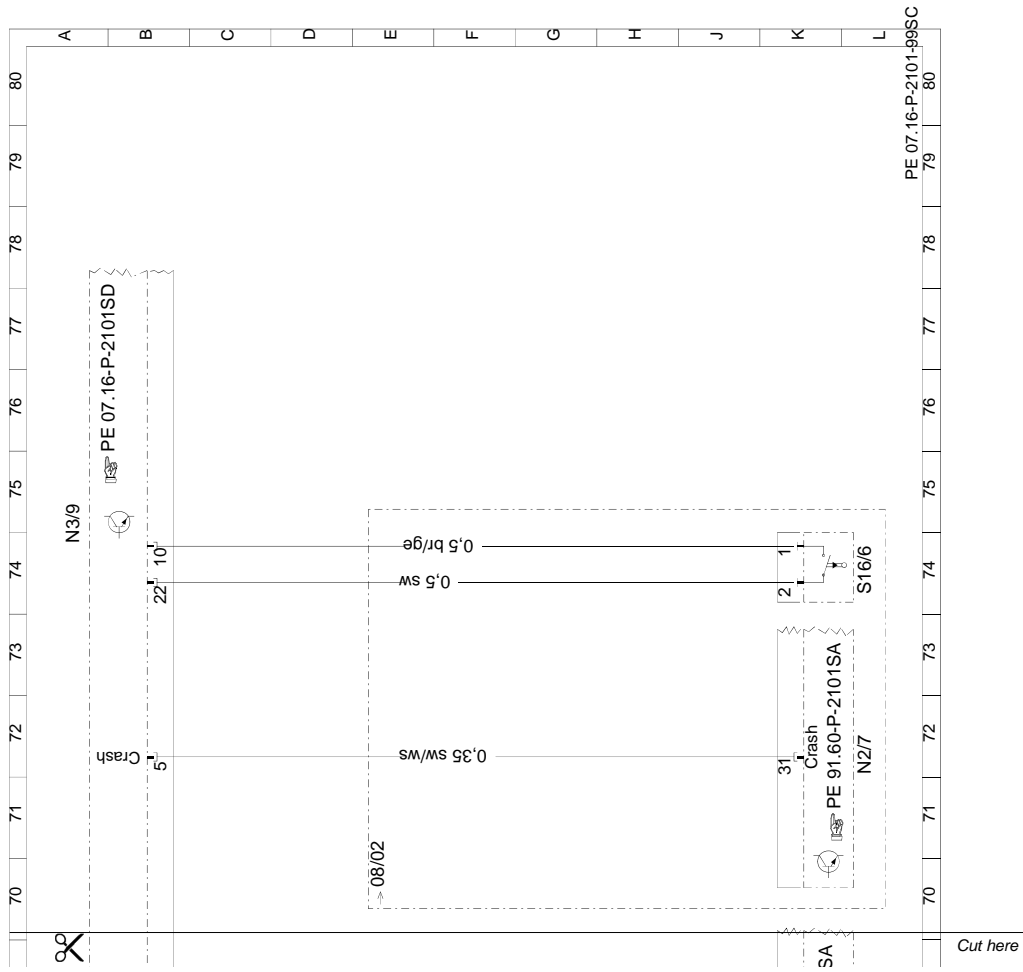

Wiring diagram of common rail diesel injection (CDI) control module / pe07.16-p-2101-99sc
ENGINE 628 in MODEL 220 control module n3/9, sheet 1 / Printed on: 17.02.2019 / Page 5/5

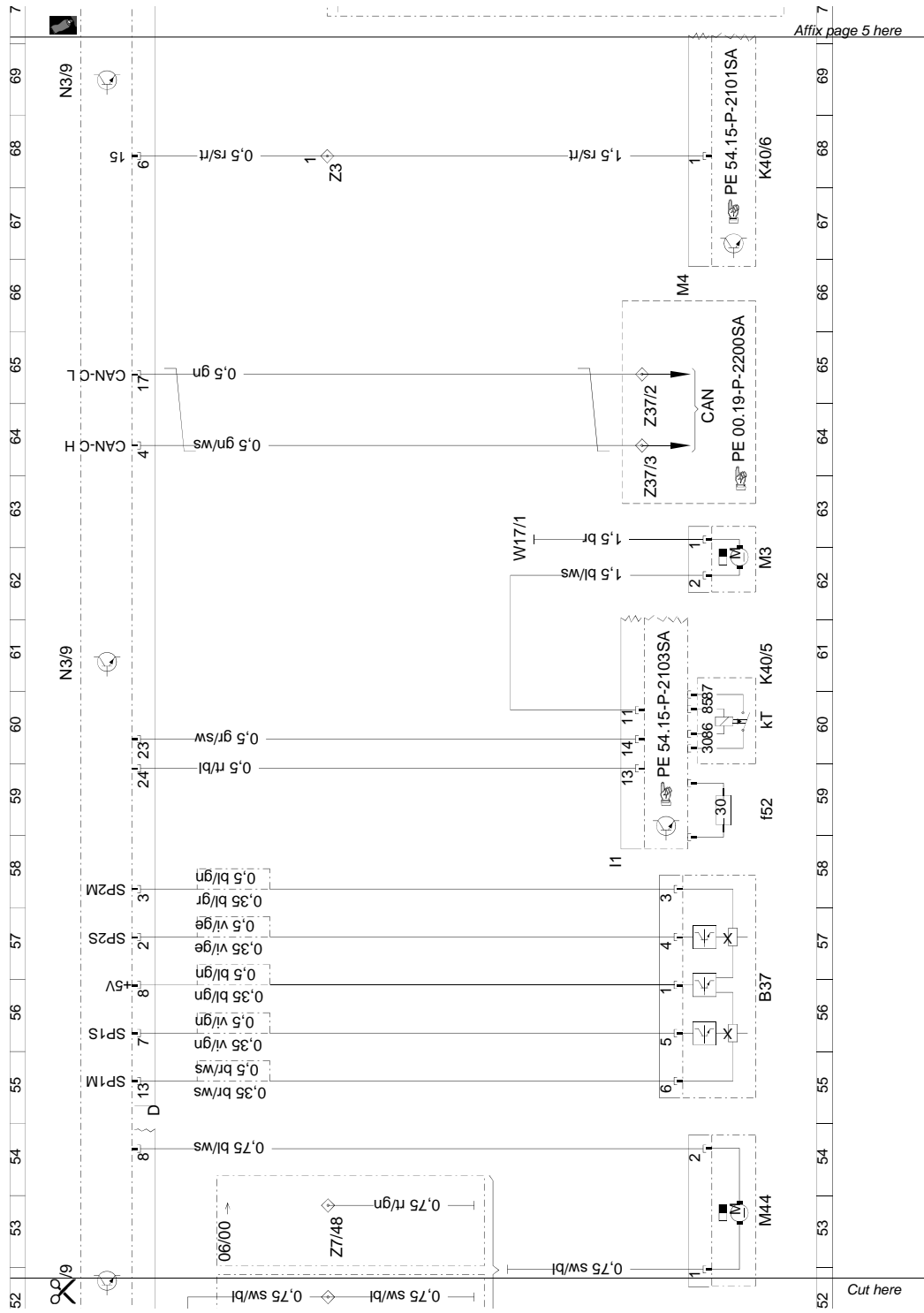

Wiring diagram of common rail diesel injection (CDI) control module / pe07.16-p-2101-99sc
ENGINE 628 in MODEL 220 control module n3/9, sheet 1 / Printed on: 17.02.2019 / Page 4/5

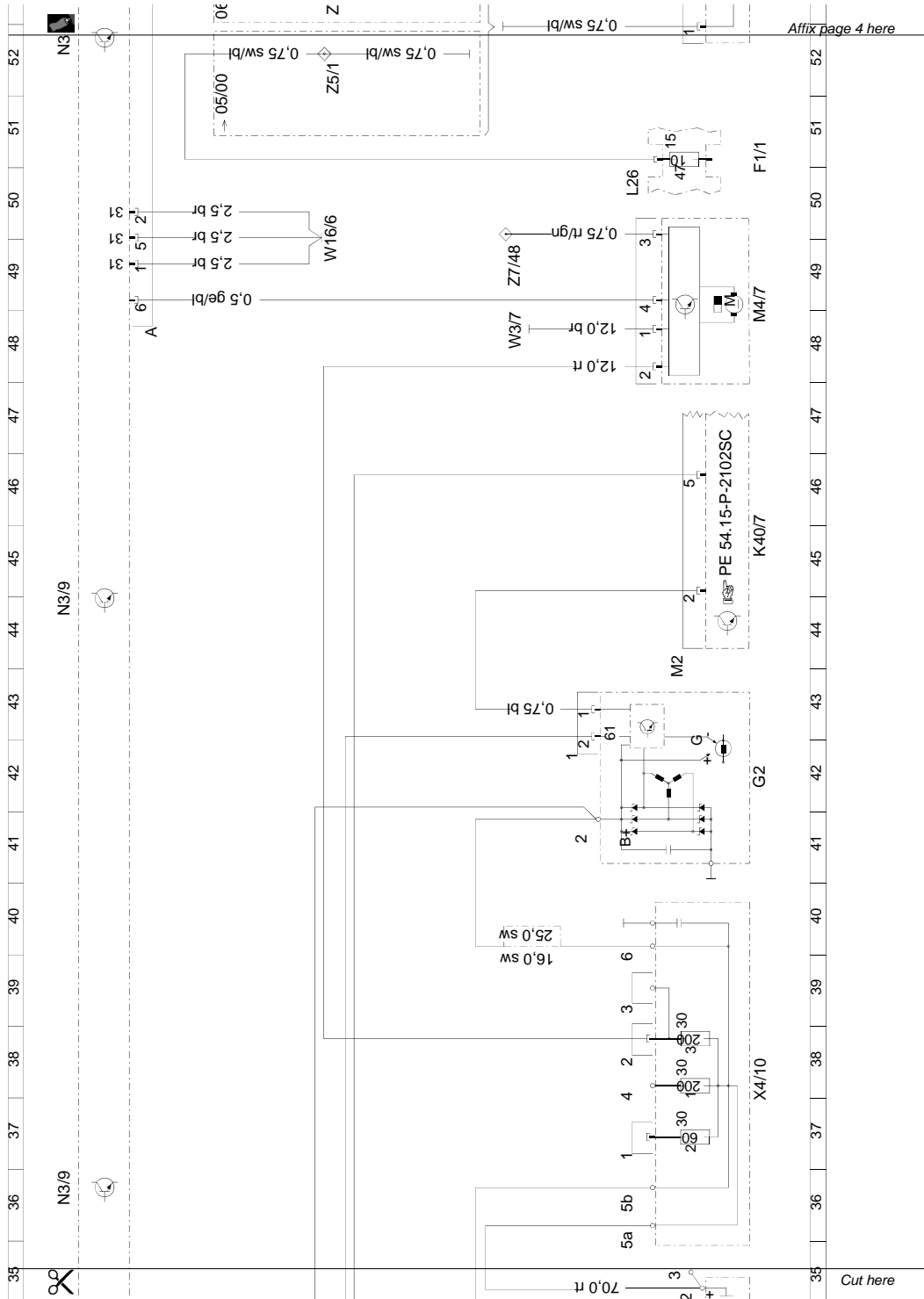

Wiring diagram of common rail diesel injection (CDI) control module / pe07.16-p-2101-99sc
ENGINE 628 in MODEL 220 control module n3/9, sheet 1 / Printed on: 17.02.2019 / Page 3/5

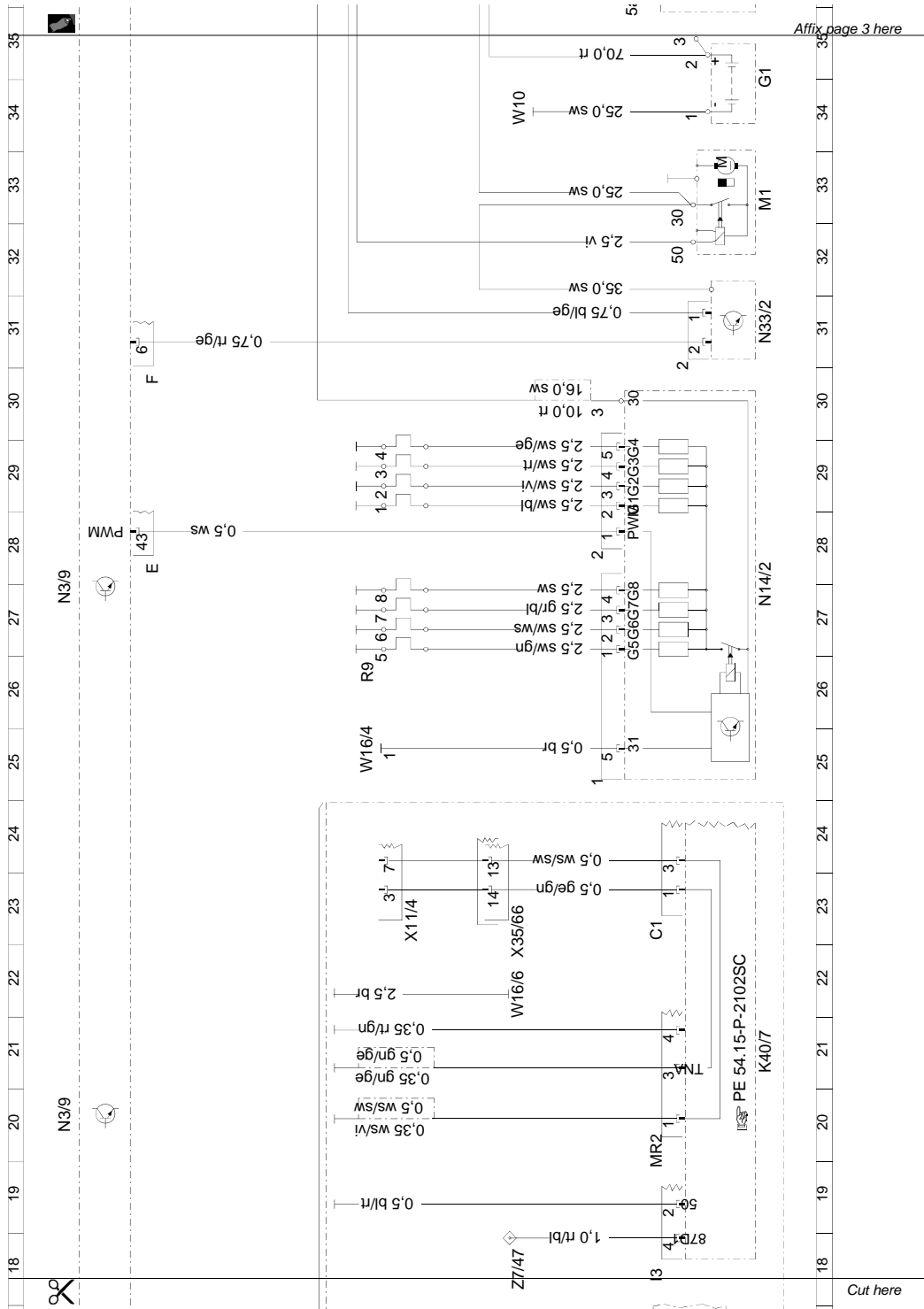

Wiring diagram of common rail diesel injection (CDI) control module / pe07.16-p-2101-99sc
ENGINE 628 in MODEL 220 control module n3/9, sheet 1 / Printed on: 17.02.2019 / Page 2/5

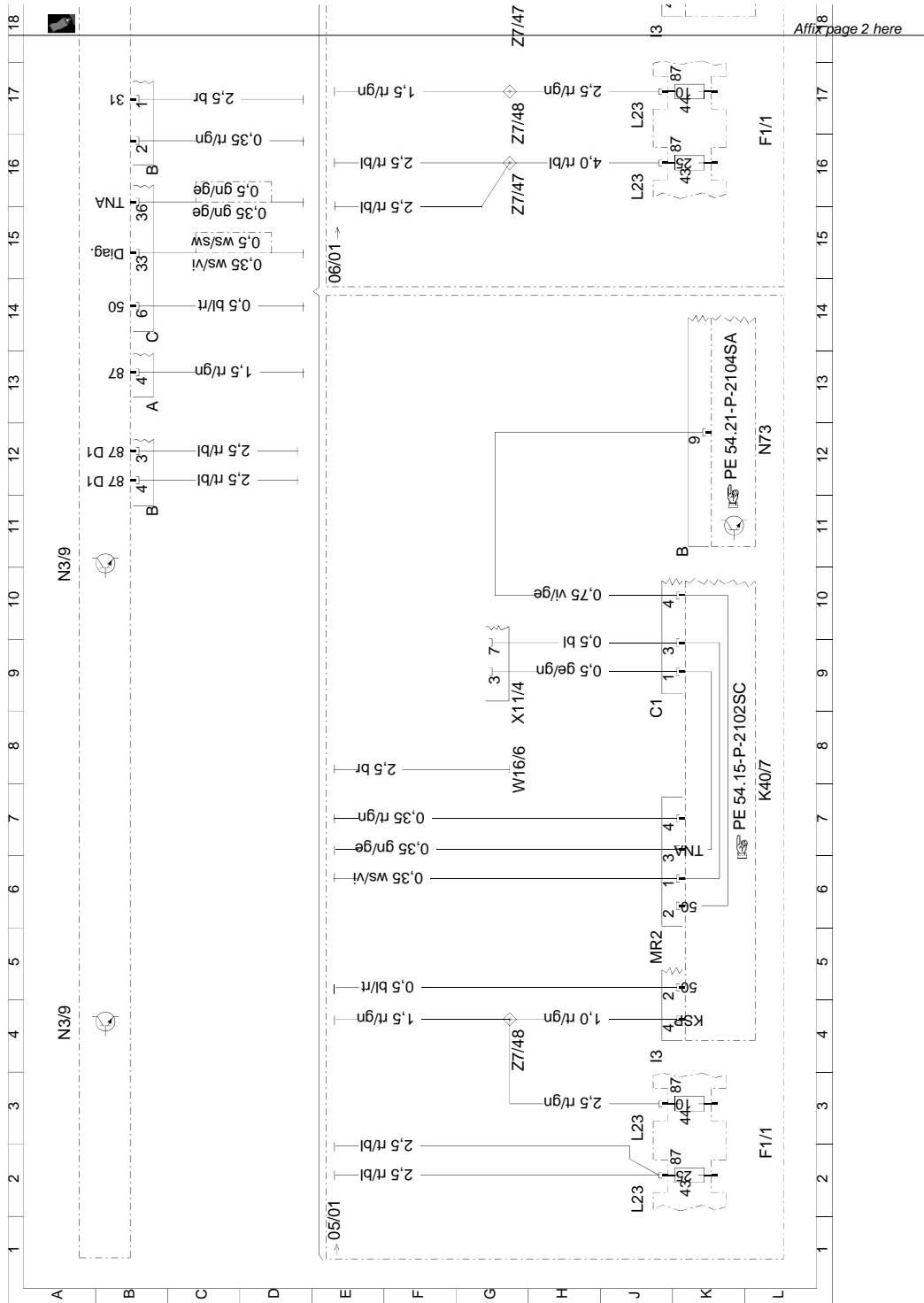

Wiring diagram of common rail diesel injection (CDI) control module / pe07.16-p-2101-99sc
ENGINE 628 in MODEL 220 control module n3/9, sheet 1 / Printed on: 17.02.2019 / Page 1/5

H.4 Factory diagrams W163 ML400CDI

Document number: pe07.16-p-2000-99gq
Document title: Wiring diagram of common rail diesel injection (CDI) control unit

Code:	Designation:	Coordinates:
B37	Accelerator pedal sensor	43 L
F1	Fuse and relay module	2 C
F1	Fuse and relay module	27 L
F1f14	Fuse 14	13 C
F1f38	Fuse 38	10 C
F1k11	Diesel voltage supply relay	11 C
F1k12	Circuit 15 relay	5 C
F1k3	Fuel pump relay module	9 C
F24/7	Circuit 30 auxiliary fuse, suction fan	40 G
F24/8	Circuit 15 auxiliary fuse	13 L
G1	Battery	5 H
G1	Battery	40 F
M3	FP assembly	10 L
M4/7	Electric suction fan engine and AC with integrated control	38 L
N10	All-activity module	4 A
N10	All-activity module	12 A
N10/1	Extended Activity module (EAM)	49 A
N2/7	Restraint systems control module	32 L
N3/9	CDI control module	19 A
N3/9	CDI control module	31 A
N3/9	CDI control module	41 A
S16/6	Kickdown switch	30 L
S2	Starter switch	4 L
S40/4	CC with variable speed limiter switch	48 L
S40/4s1	Resume from memory	46 J
S40/4s2	Decelerate and set	50 J
S40/4s3	Accelerate and set	49 J
S40/4s4	Off	45 J
S40/4s5	Control contact	48 J
S40/4s6	Variable speed	50 K
S40/4v1	Yellow LED, variable speed limiter	49 K
W16/4	Ground (output ground - component compartment - right)	6 L
W16/4	Ground (output ground - component compartment - right)	40 C
W16/5	Electronics ground (left of component compartment)	21 F
W2	Ground (at right headlamp unit)	39 C
W29/2	Ground (right A-pillar)	29 G
W6	Ground (left wheelhousing in trunk)	9 L
X12/12	Circuit 30 terminal block at relay module 1	3 E
X12/13	Circuit 15 terminal block at relay module 1	4 E

Document number: pe07.16-p-2000-99gq
Document title: Wiring diagram of common rail diesel injection (CDI) control unit

Code:	Designation:	Coordinates:
X12/14	Circuit 31 terminal block at relay module 1	5 E
X18/3	Interior/fuel tank connector	9 H
X25/2	Engine compartment/interior compartment connector	27 G
X26	Engine compartment/cockpit connector	25 J
X36/4	Fuel tank filler neck/ground screw connection	8 L
X4/37	Terminal block (circuit 30)	4 F
Z37/2	CAN engine bus (low) connector sleeve	33 E
Z37/3	CAN engine bus (high) connector sleeve	33 E
Z50/11	CAN-L cockpit connector sleeve	51 D
Z50/12	CAN-H cockpit connector sleeve	50 D
Z50/3	Cockpit connector sleeve (circuit 31, I left)	50 F
Z50/5	Cockpit circuit 30 connector sleeve	3 G
Z50/6	Cockpit connector sleeve (circuit 15C)	1 H
Z50/9	Cockpit connector sleeve (circuit 15 II)	2 F
Z51/14	Interior connector sleeve, analog crash signal	31 J
Z51/3	Interior connector sleeve (CAN-High 2)	34 K
Z51/4	Interior connector sleeve (CAN-Low 2)	33 K
Z51/8	Interior connector sleeve II (circuit 31, right front)	29 J
Z52/2	Interior connector sleeve V (circuit 31, left rear)	9 G
Z57/11	Right engine compartment, circuit 15 connector sleeve	21 H
Z57/11	Right engine compartment, circuit 15 connector sleeve	38 F
Z57/7	Right engine compartment connector sleeve, circuit 31 (3)	20 D

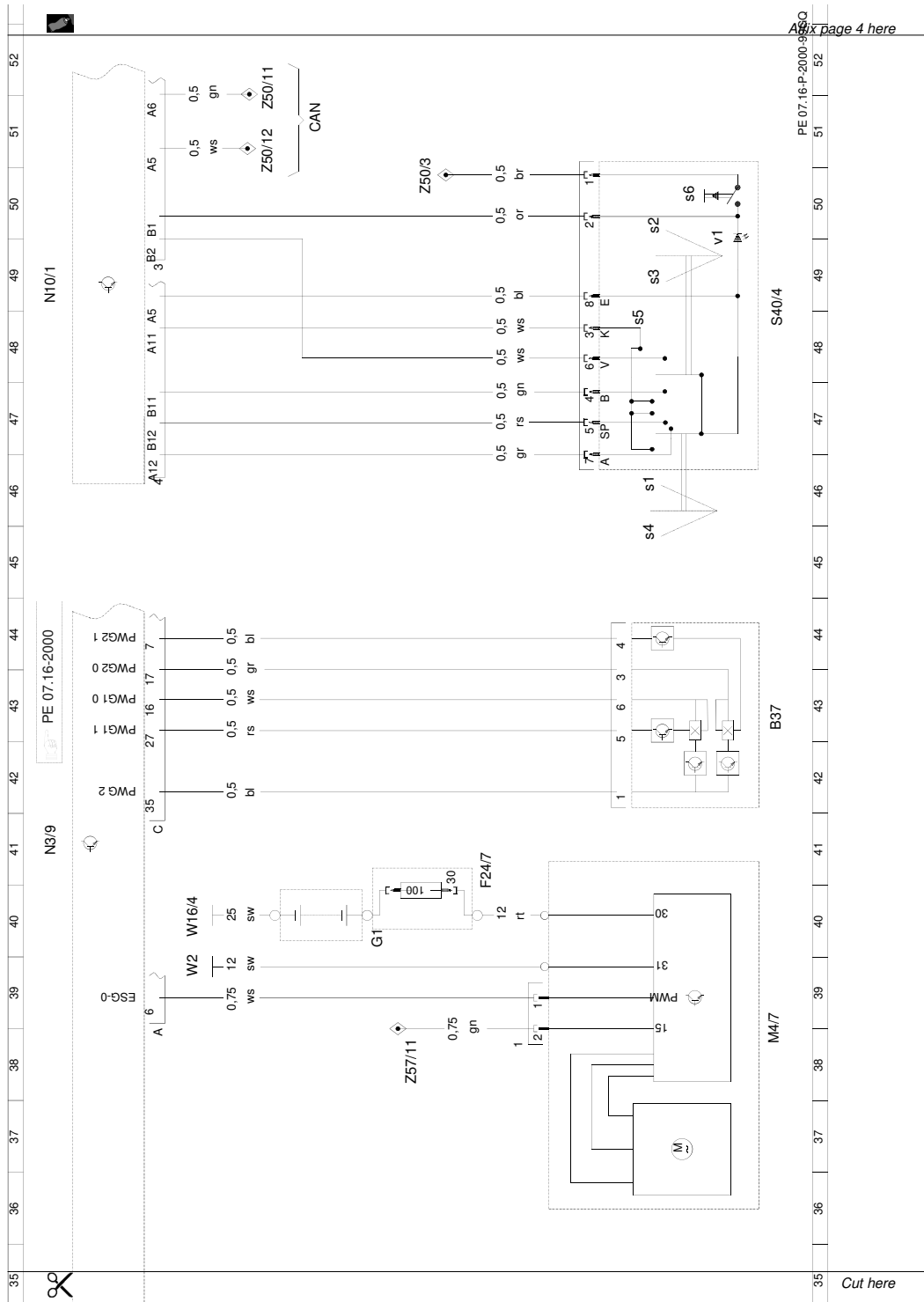

Wiring diagram of common rail diesel injection (CDI) control unit / pe07.16-p-2000-99gq ENGINE 628 in MODEL 163 as of 1.9.02 / Printed on: 19.08.2021 / Page 3/4

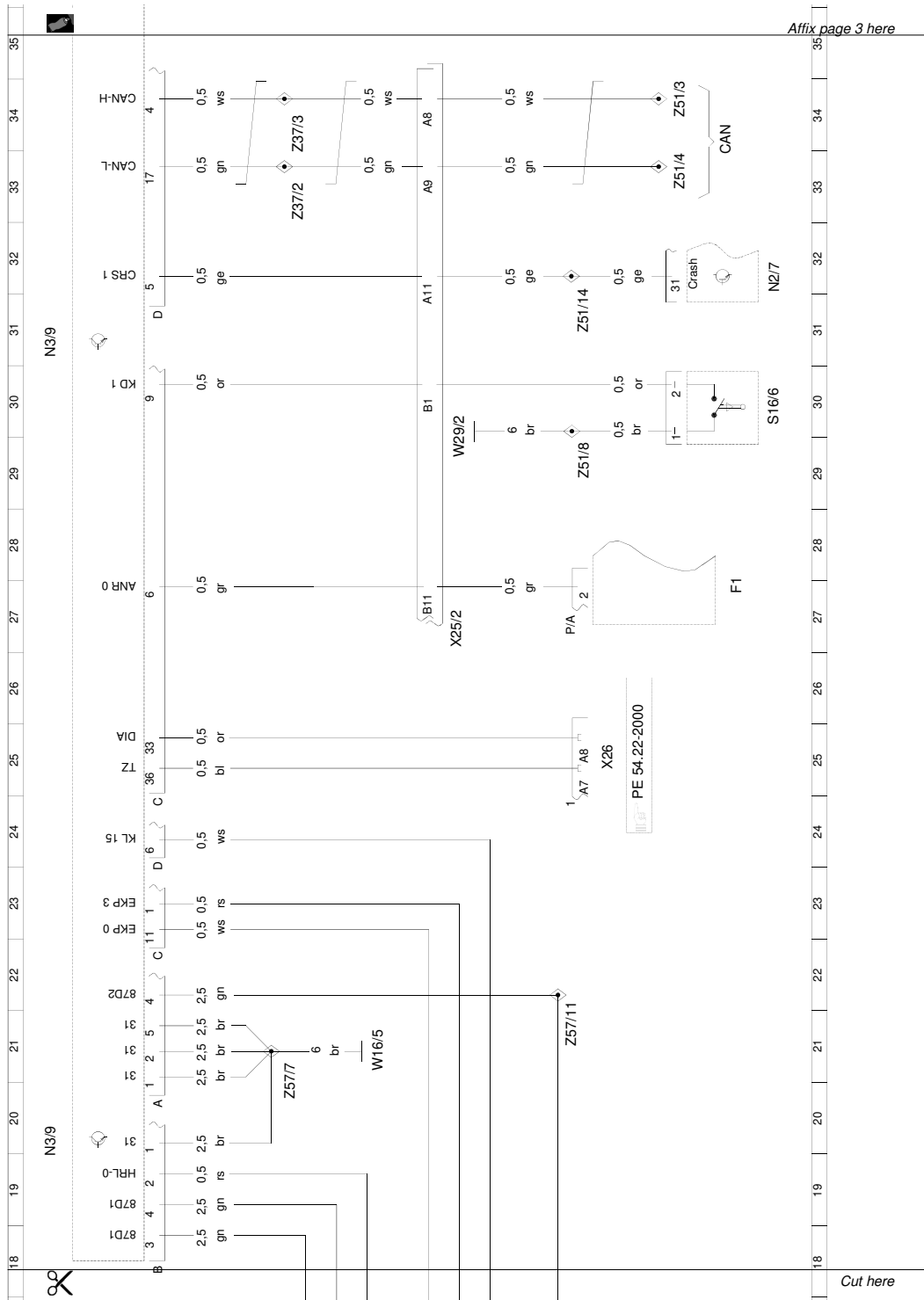

Wiring diagram of common rail diesel injection (CDI) control unit / pe07.16-p-2000-99gq
ENGINE 628 in MODEL 163 as of 1.9.02 / Printed on: 19.08.2021 / Page 2/4

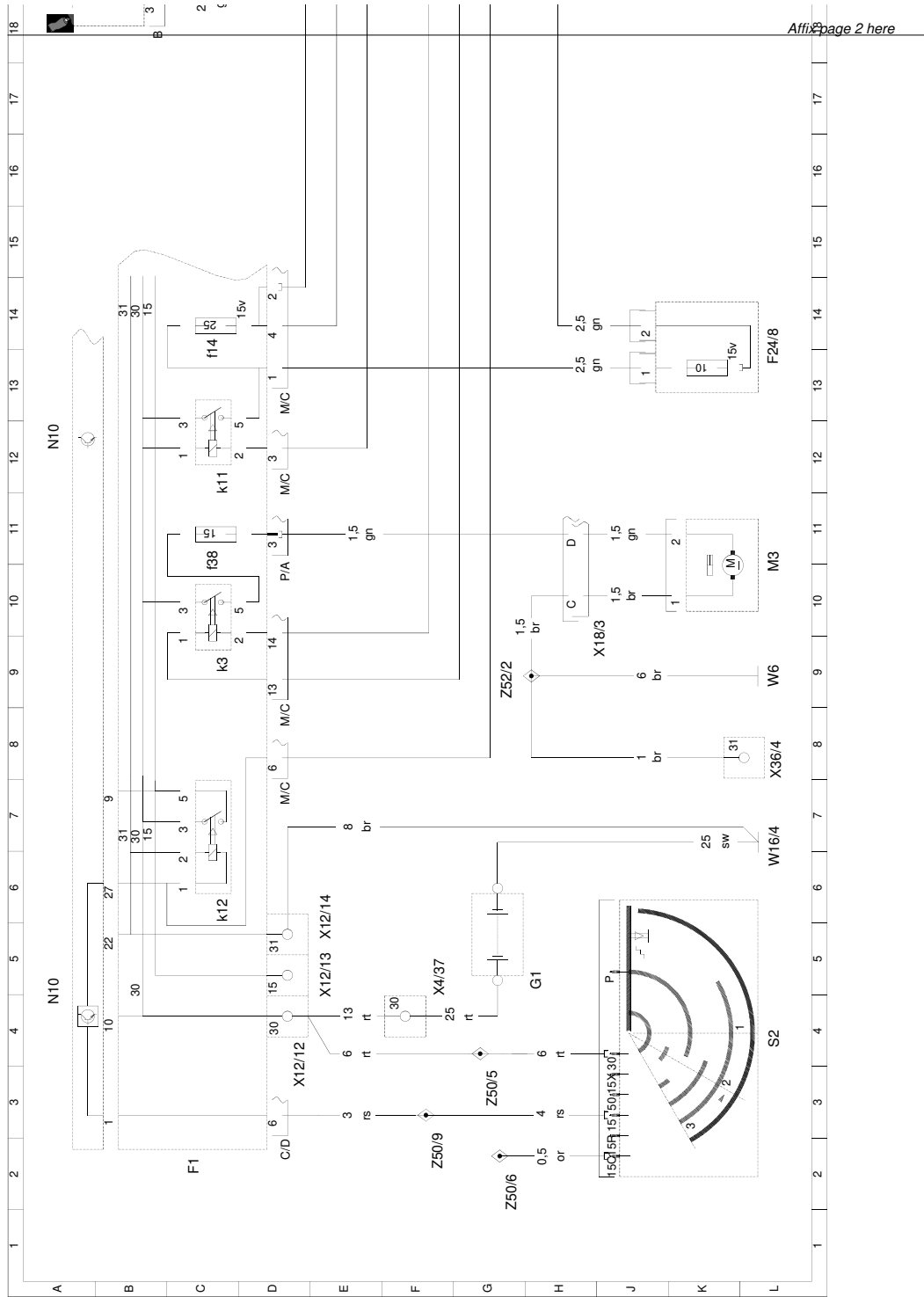

Wiring diagram of common rail diesel injection (CDI) control unit / pe07.16-p-2000-99gq
ENGINE 628 in MODEL 163 as of 1.9.02 / Printed on: 19.08.2021 / Page 1/4

Document number: pe07.16-p-2000-99gp
Document title: Wiring diagram of common rail diesel injection (CDI) control unit

Code:	Designation:	Coordinates:
B11/4	Coolant temperature sensor	31 L
B17	Intake air temperature sensor	32 L
B2/6	Left hot film MAF sensor	36 L
B2/7	Right hot film MAF sensor	41 L
B28	Pressure sensor	43 L
B28	Pressure sensor	45 L
B4/6	Rail pressure sensor	34 L
B40	Oil sensor (oil level, temperature and quality)	38 L
B6/1	Camshaft Hall sensor	57 L
F1	Fuse and relay module	1 C
F1	Fuse and relay module	12 C
F1	Fuse and relay module	22 L
F1f14	Fuse 14	11 C
F1k11	Diesel voltage supply relay	9 D
F1k12	Circuit 15 relay	5 D
F24/8	Circuit 15 auxiliary fuse	11 L
G1	Battery	4 H
G2	Generator	29 C
L5	Crankshaft position sensor	56 L
N10	All-activity module	2 A
N10	All-activity module	11 A
N14/2	Preglow output	26 L
N3/9	CDI control module	17 A
N3/9	CDI control module	27 A
N3/9	CDI control module	37 A
N3/9	CDI control module	47 A
N3/9	CDI control module	57 A
N3/9	CDI control module	67 A
N3/9	CDI control module	77 A
R9	Glow plugs	24 C
R9	Glow plugs	25 C
R9	Glow plugs	26 C
R9	Glow plugs	26 C
R9	Glow plugs	27 C
R9	Glow plugs	27 C
R9	Glow plugs	27 C
R9	Glow plugs	28 C
R9	Glow plugs	28 C
S2	Starter switch	3 L
W16/4	Ground (output ground - component compartment - right)	6 L

Document number: pe07.16-p-2000-99gp
Document title: Wiring diagram of common rail diesel injection (CDI) control unit

Code:	Designation:	Coordinates:
W16/5	Electronics ground (left of component compartment)	18 F
W2	Ground (at right headlamp unit)	28 H
X12/12	Circuit 30 terminal block at relay module 1	3 E
X12/13	Circuit 15 terminal block at relay module 1	4 E
X12/14	Circuit 31 terminal block at relay module 1	5 E
X25/2	Engine compartment/interior compartment connector	21 G
X4/37	Terminal block (circuit 30)	4 F
Y100	Left charge pressure positioner	51 L
Y100/1	Right charge pressure positioner	53 L
Y27/10	Right exhaust gas recirculation positioner	48 L
Y27/9	Left exhaust gas recirculation positioner	46 L
Y74	Pressure regulator valve	61 L
Y76y1	Fuel injector (1st cylinder)	65 L
Y76y2	Fuel injector (2nd cylinder)	76 L
Y76y3	Fuel injector (3rd cylinder)	74 L
Y76y4	Fuel injector (4th cylinder)	69 L
Y76y5	Fuel injector cylinder 5	72 L
Y76y6	Fuel injector cylinder 6	67 L
Y76y7	Fuel injector cylinder 7	70 L
Y76y8	Fuel injector cylinder 8	78 L
Y83	Inlet port shutoff switchover valve	63 L
Y94	Volume control valve	59 L
Z50/5	Cockpit circuit 30 connector sleeve	2 G
Z50/6	Cockpit connector sleeve (circuit 15C)	1 H
Z50/9	Cockpit connector sleeve (circuit 15 II)	1 G
Z57/11	Right engine compartment, circuit 15 connector sleeve	18 F
Z57/7	Right engine compartment connector sleeve, circuit 31 (3)	18 D
Z6/18	Electronics ground connector sleeve	34 F
Z6/18	Electronics ground connector sleeve	39 F
Z6/30	Circuit 31 connector sleeve	37 F
Z6/30	Circuit 31 connector sleeve	42 F
Z6/30	Circuit 31 connector sleeve	51 F
Z6/30	Circuit 31 connector sleeve	53 F
Z99/6	Common rail solenoid valve 1 connector sleeve	65 F
Z99/7	Common rail solenoid valve 2 connector sleeve	72 F

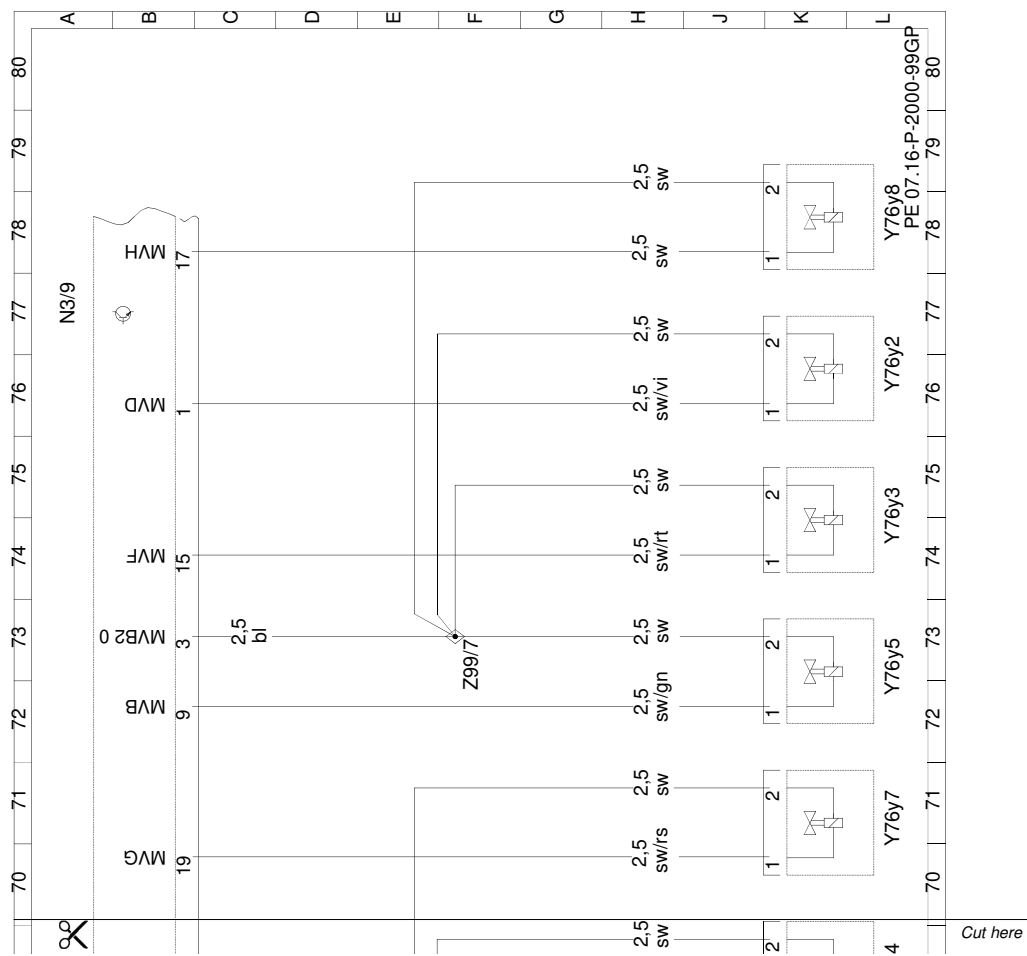

Wiring diagram of common rail diesel injection (CDI) control unit / pe07.16-p-2000-99gp
ENGINE 628 in MODEL 163 as of 1.9.02 / Printed on: 19.08.2021 / Page 5/5

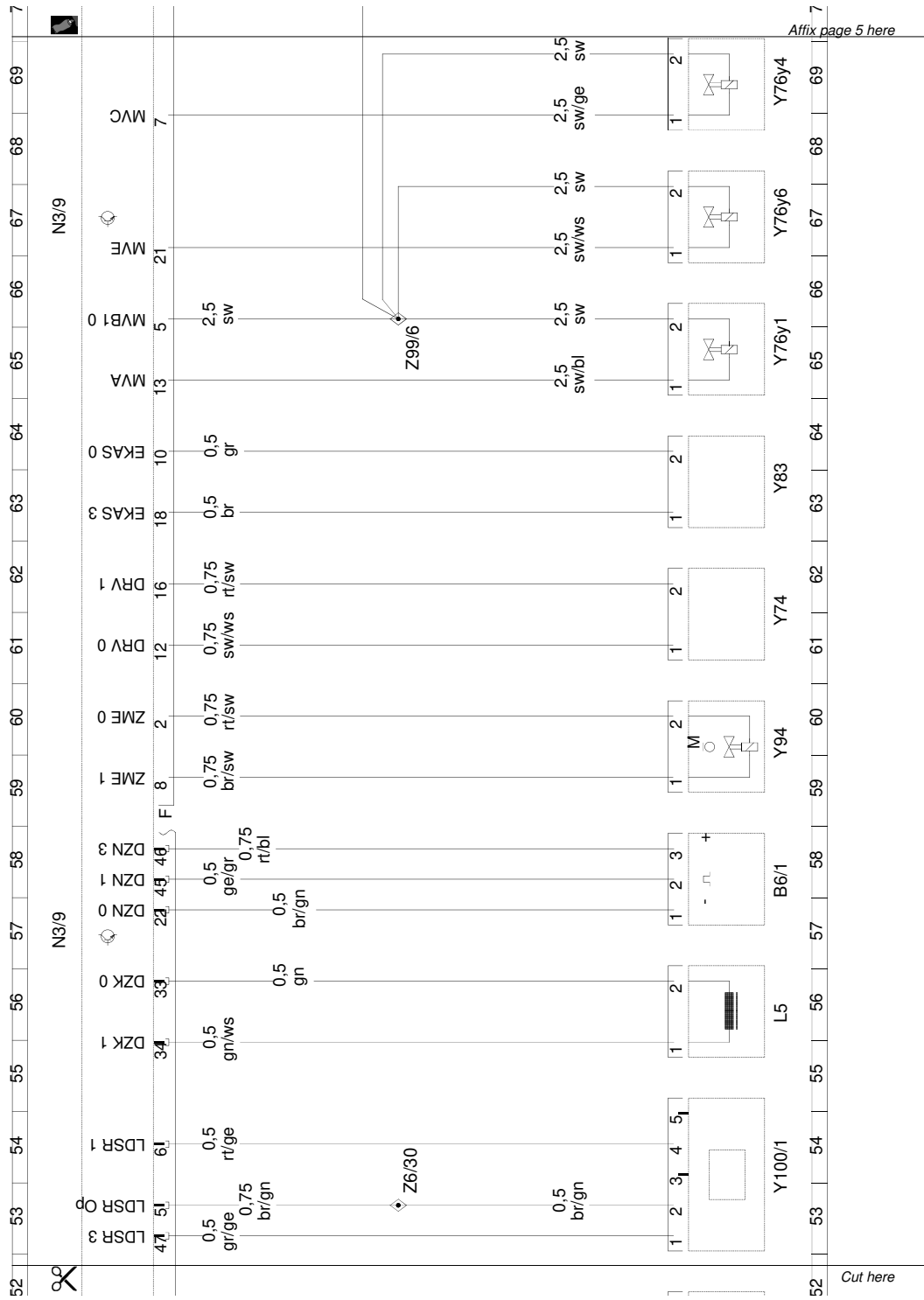

Wiring diagram of common rail diesel injection (CDI) control unit / pe07.16-p-2000-99gp
ENGINE 628 in MODEL 163 as of 1.9.02 / Printed on: 19.08.2021 / Page 4/5

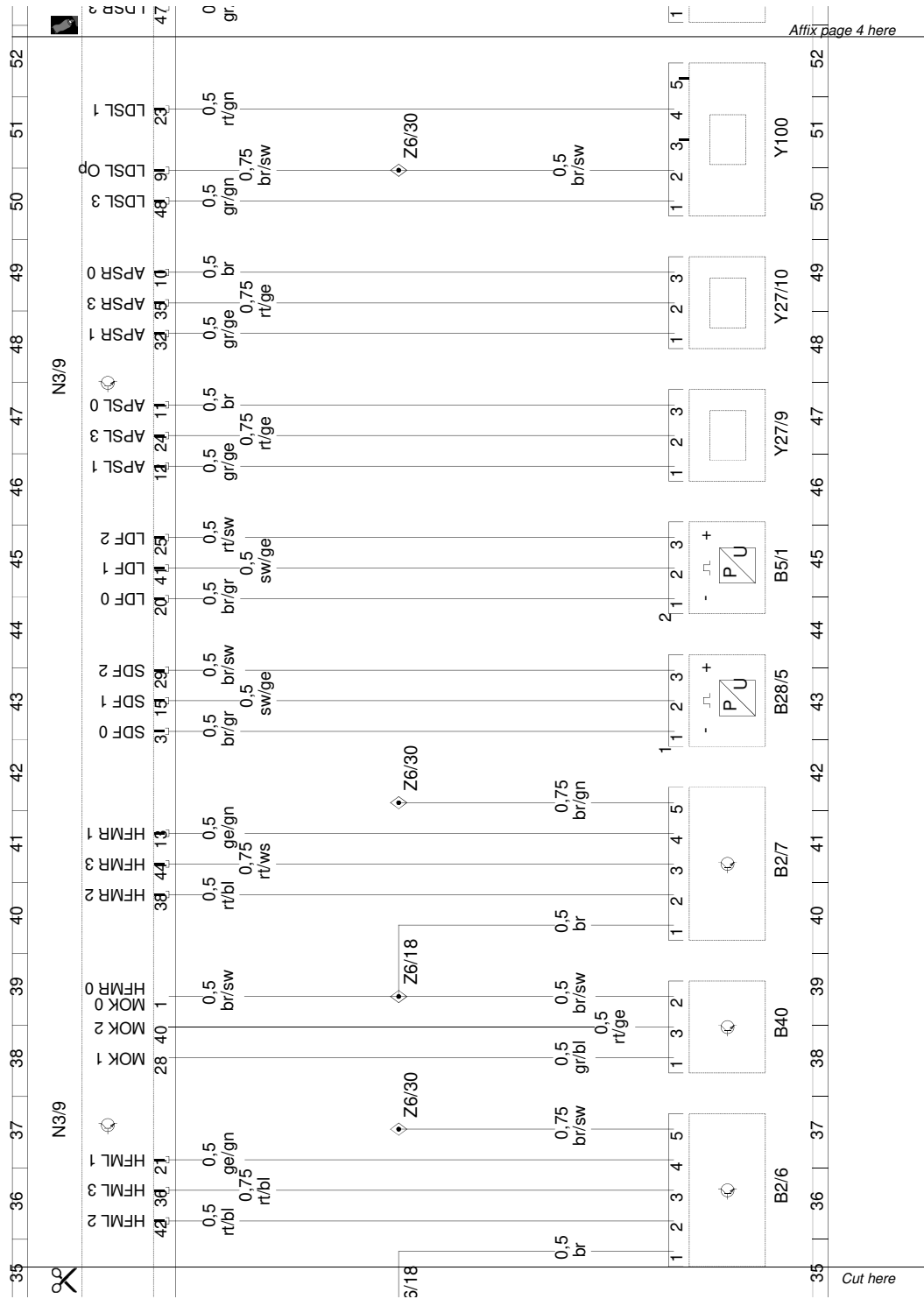

Affix page 4 here

Cut here

Wiring diagram of common rail diesel injection (CDI) control unit / pe07.16-p-2000-99gp
ENGINE 628 in MODEL 163 as of 1.9.02 / Printed on: 19.08.2021 / Page 3/5

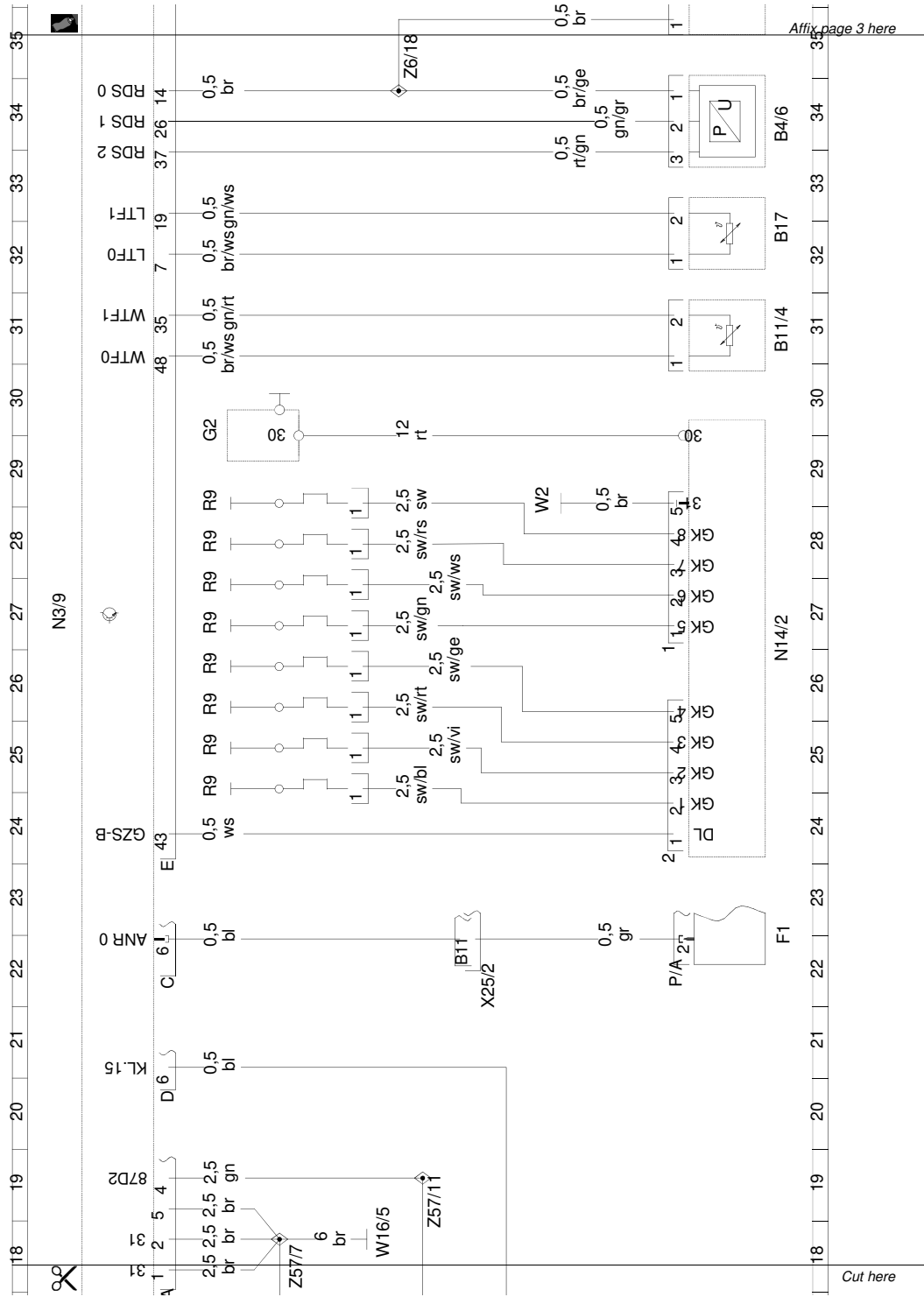

Wiring diagram of common rail diesel injection (CDI) control unit / pe07.16-p-2000-99gp
ENGINE 628 in MODEL 163 as of 1.9.02 / Printed on: 19.08.2021 / Page 2/5

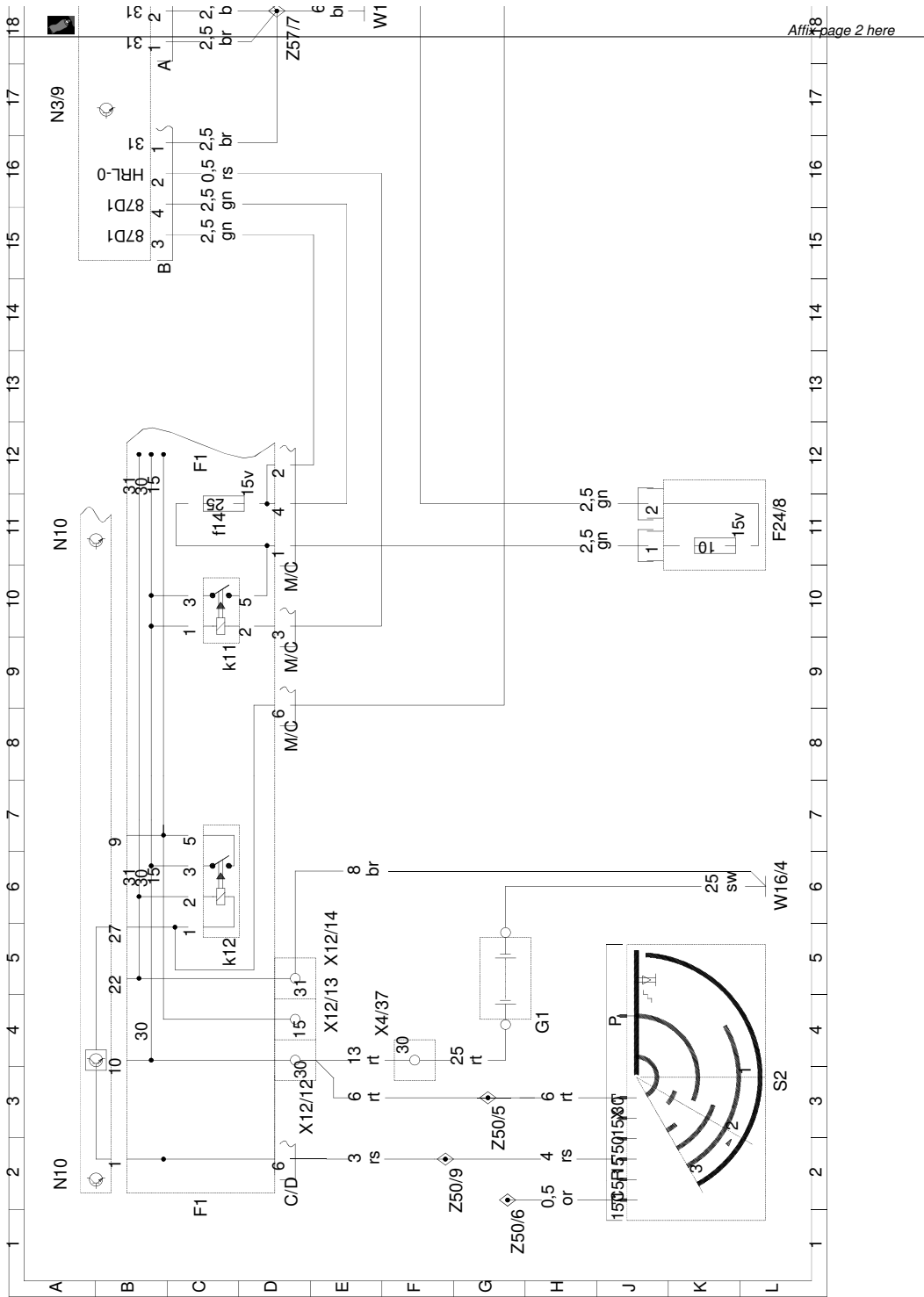

Wiring diagram of common rail diesel injection (CDI) control unit / pe07.16-p-2000-99gp
ENGINE 628 in MODEL 163 as of 1.9.02 / Printed on: 19.08.2021 / Page 1/5

H.5 Factory diagrams W463 G400CDI

Document number: pe07.16-p-2101-99gd
Document title: Wiring diagram for common rail diesel injection (CDI) control unit

Code:	Designation:	Coordinates:
F2	Fusebox (8 fuses)	18 L
F2	Fusebox (8 fuses)	34 L
F2f4	Fuse 4	34 K
F2f7	Fuse 7	18 K
F32	Front prefuse	5 L
F32	Front prefuse	56 L
F32f3	Prefuse 3	56 K
F32f5	Prefuse 5	5 K
K6	Starter relay	21 L
M1	Starter	58 L
M4/7	Engine and AC electric suction fan with integrated control	7 L
M44	Charge air cooler circulation pump	2 L
N10/1	Front signal acquisition and actuation module (SAM)	13 L
N10/1	Front signal acquisition and actuation module (SAM)	47 L
N10/1	Front signal acquisition and actuation module (SAM)	53 A
N10/2	Rear signal acquisition and actuation module (SAM)	38 L
N14/2	Glow output stage	56 A
N2/7	Restraint systems control unit	41 L
N3/9	CDI control unit	2 A
N3/9	CDI control unit	7 A
N3/9	CDI control unit	14 A
N3/9	CDI control unit	20 A
N3/9	CDI control unit	26 A
N3/9	CDI control unit	32 A
N3/9	CDI control unit	38 A
N3/9	CDI control unit	44 A
N3/9	CDI control unit	50 A
N33/2	Heater booster control unit	60 A
R25	Electronic accelerator (EA [EFP]) position sensor	36 L
S16/6	Kickdown switch	50 L
S4/3	Heater booster switch	31 L
S41	Coolant level indicator switch	52 L
S42	Windshield washer fluid level indicator switch	54 L
U297	Valid for diesel engines except OM648OM648	57 D
U297	Valid for diesel engines except OM648OM648	59 D
W26	Ground (restraint systems control unit)	29 L
W29/1	Ground (left A-pillar)	51 L
W3/1	Ground (right front wheelhouse)	6 L
W3/1	Ground (right front wheelhouse)	9 L

Document number: pe07.16-p-2101-99gd
Document title: Wiring diagram for common rail diesel injection (CDI) control unit

Code:	Designation:	Coordinates:
W3/1	Ground (right front wheelhouse)	10 L
W3/1	Ground (right front wheelhouse)	10 L
W3/1	Ground (right front wheelhouse)	12 L
X11/4	Data link connector	26 L
X15	Engine fan connector/100°C temperature switch	7 G
X18/7	Interior/engine connector	24 L
X4/30	Circuit 30 engine terminal block	61 L
X63/4	CAN databus adapter connector (2-pin)	43 L
Z20/35	CAN bus screening end	45 H
Z7/35	Circuit 87M1e connector sleeve	16 L
Z7/35	Circuit 87M1e connector sleeve	17 L
Z7/35	Circuit 87M1e connector sleeve	25 L
Z7/36	Circuit 87M2e connector sleeve	3 L
Z7/36	Circuit 87M2e connector sleeve	4 L
Z7/36	Circuit 87M2e connector sleeve	11 L
Z73/6	CAN bus shielding solder terminal	46 L
Z81/6	Circuit 58d connector sleeve	29 L

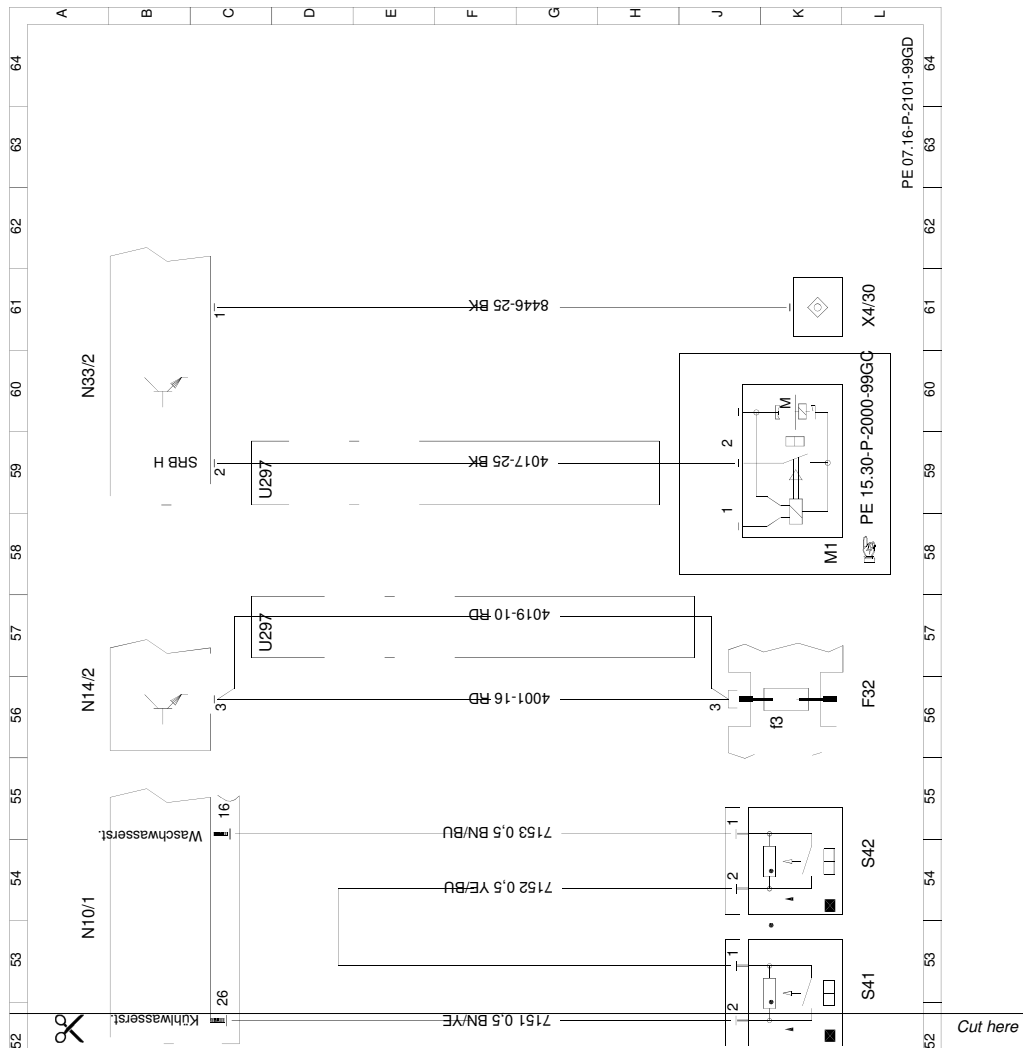

Wiring diagram for common rail diesel injection (CDI) control unit / pe07.16-p-2101-99gd
ENGINE 628.962 in MODEL 463.309 /332 /333 ## as of 1.9.03 up to 156037 Sheet 1 / Printed on: 19.08.2021 / Page 4/4

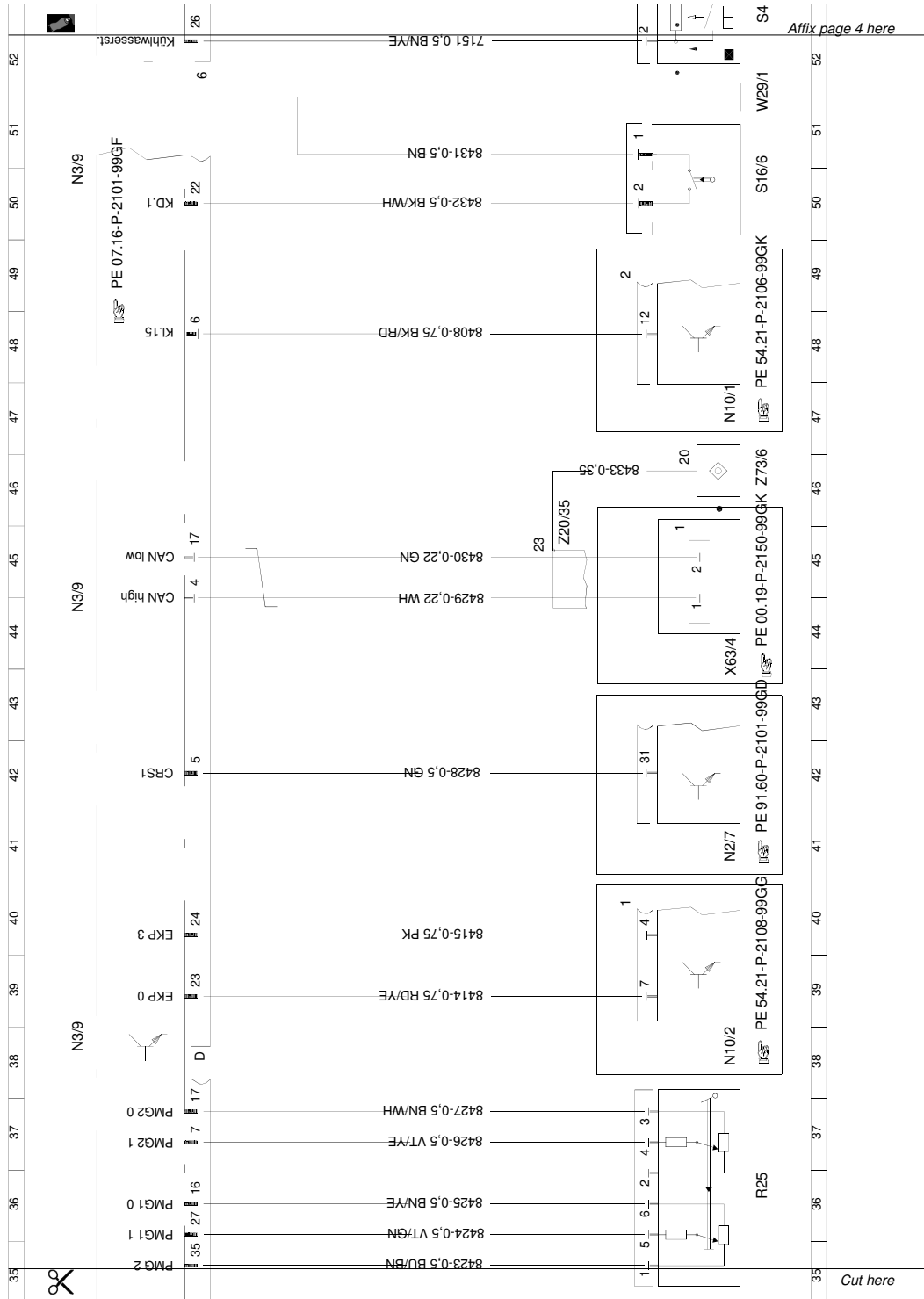

Wiring diagram for common rail diesel injection (CDI) control unit / pe07.16-p-2101-99gd
ENGINE 628.962 in MODEL 463.309 /332 /333 ## as of 1.9.03 up to 156037 Sheet 1 / Printed on: 19.08.2021 / Page 3/4

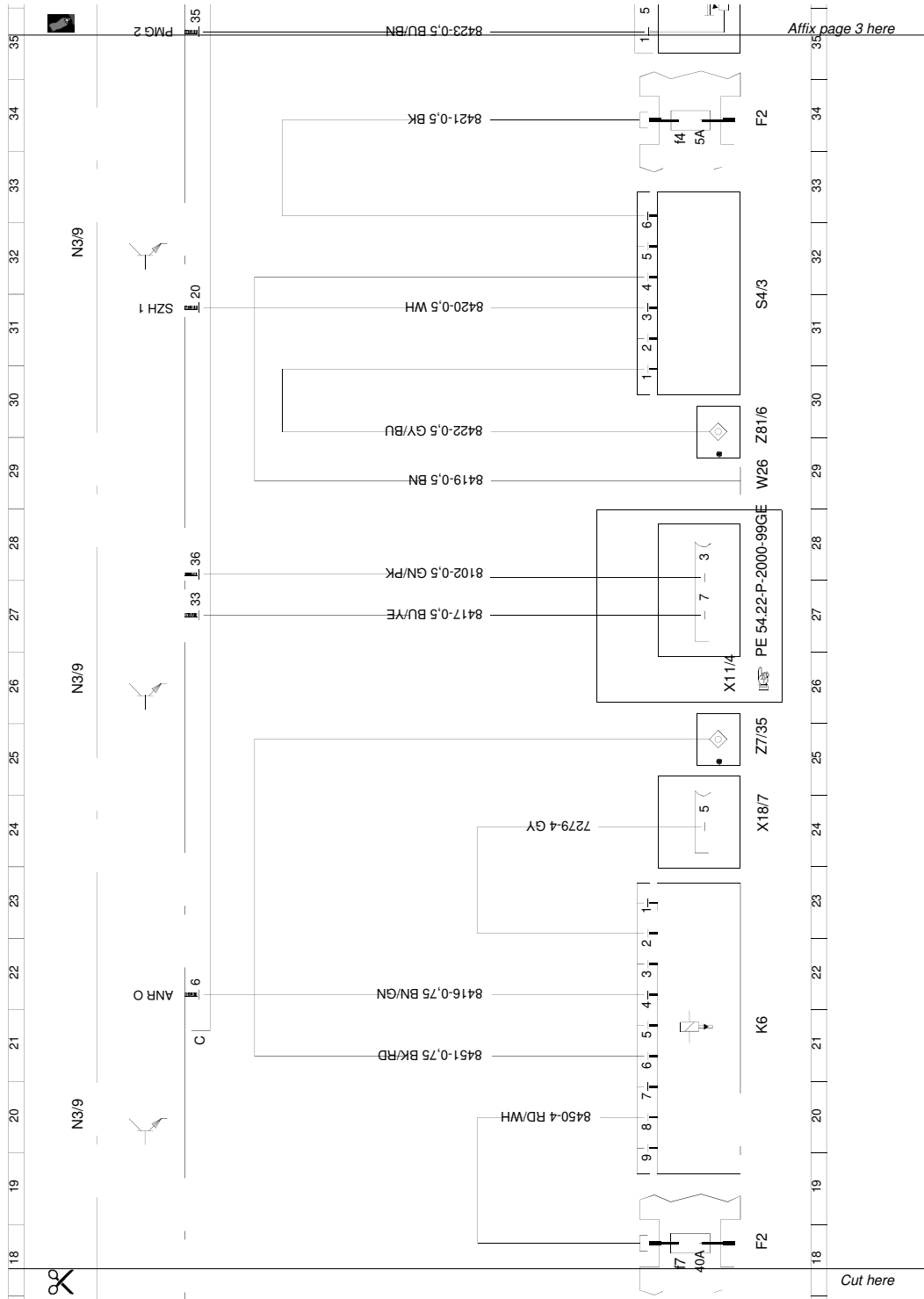

Wiring diagram for common rail diesel injection (CDI) control unit / pe07.16-p-2101-99gd
ENGINE 628.962 in MODEL 463.309 /332 /333 ## as of 1.9.03 up to 156037 Sheet 1 / Printed on: 19.08.2021 / Page 2/4

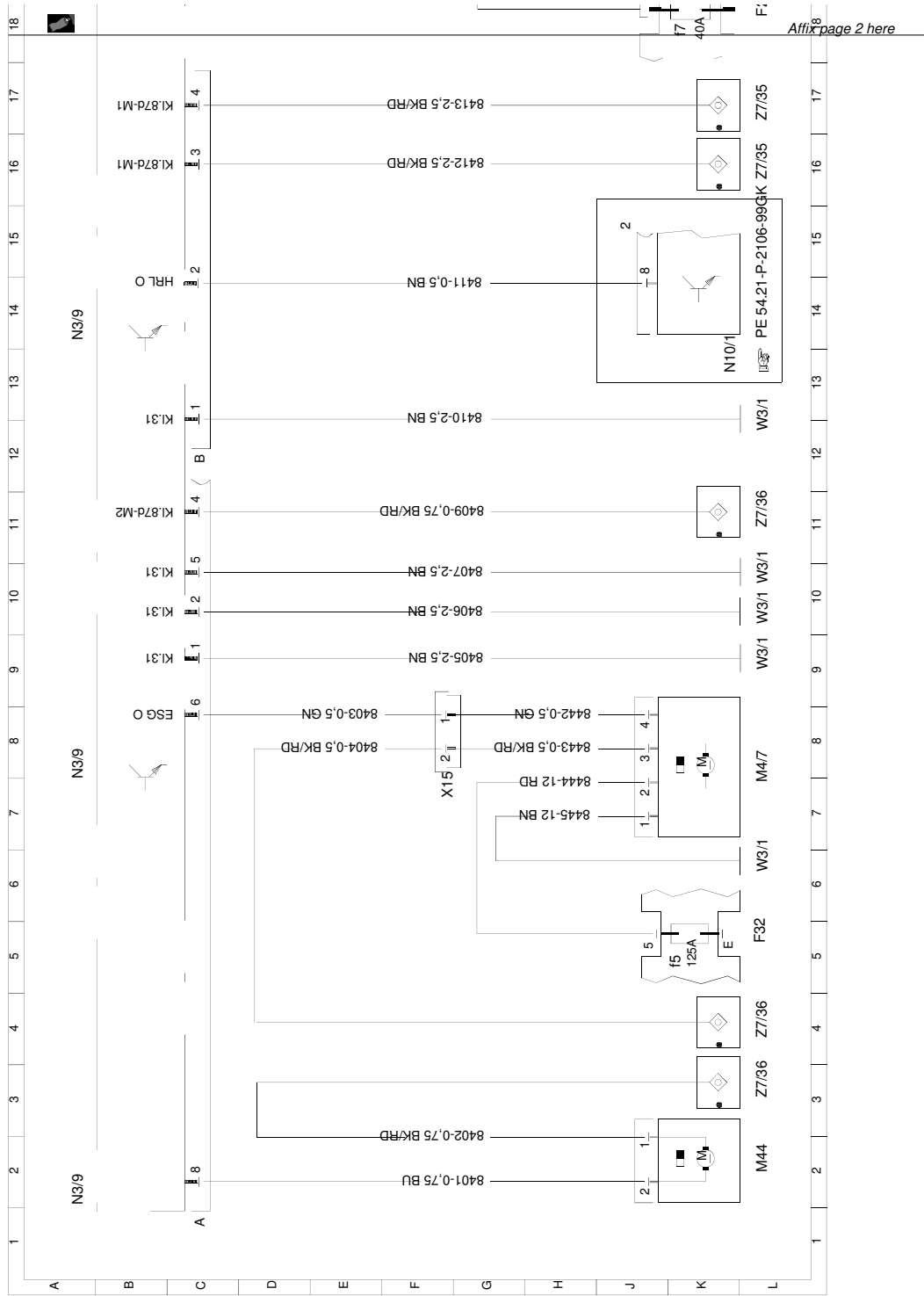

Wiring diagram for common rail diesel injection (CDI) control unit / pe07.16-p-2101-99gd
 ENGINE 628.962 in MODEL 463.309 /332 /333 ## as of 1.9.03 up to 156037 Sheet 1 / Printed on: 19.08.2021 / Page 1/4

Document number: pe07.16-p-2101-99gf
Document title: Wiring diagram for common rail diesel injection (CDI) control unit

Code:	Designation:	Coordinates:
A9	AC compressor	28 L
B11/4	Coolant temperature sensor	38 L
B17	Intake air temperature sensor	39 L
B2/6	Left hot film MAF sensor	48 L
B2/7	Right hot film MAF sensor	55 L
B28	Pressure sensor	43 L
B28/5	Pressure sensor downstream of air cleaner, right cylinder bank	41 L
B4/6	Rail pressure sensor	45 L
B40	Oil sensor (oil level, temperature and quality)	53 L
B6/1	Camshaft Hall sensor	36 L
G2	Generator	22 L
L5	Crankshaft position sensor	34 L
M16/5	Throttle valve positioner	19 L
N10/1	Front signal-acquisition and actuation module (SAM)	25 L
N14/2	Preglow output	63 A
N3/9	CDI control unit	2 A
N3/9	CDI control unit	9 A
N3/9	CDI control unit	16 A
N3/9	CDI control unit	23 A
N3/9	CDI control unit	30 A
N3/9	CDI control unit	37 A
N3/9	CDI control unit	44 A
N3/9	CDI control unit	52 A
N3/9	CDI control unit	59 A
N33/2	Heater booster control unit	21 L
R9	Glow plugs	63 L
W16/4	Ground, right major assembly compartment	67 L
X18/7	Interior/engine connector	25 F
X18/7	Interior/engine connector	27 F
Y100	Left charge pressure positioner	50 L
Y100/1	Right charge pressure positioner	58 L
Y27/10	Right exhaust gas recirculation positioner	30 L
Y27/9	Left exhaust gas recirculation positioner	32 L
Y74	Pressure regulator valve	14 L
Y76/1	Fuel injector (1st cylinder)	2 L
Y76/2	Cylinder 2 fuel injector	8 L
Y76/3	Cylinder 3 fuel injector	10 L
Y76/4	Fuel injector (4th cylinder)	4 L
Y76/5	Fuel injector cylinder 5	11 L

Document number: pe07.16-p-2101-99gf

Document title: Wiring diagram for common rail diesel injection (CDI) control unit

Code:	Designation:	Coordinates:
Y76/6	Fuel injector cylinder 6	5 L
Y76/7	Fuel injector cylinder 7	7 L
Y76/8	Fuel injector cylinder 8	13 L
Y83	Inlet port shutoff switchover valve	16 L
Y94	Quantity control valve	17 L
Z6/18	Electronics ground (HFM-SFI [HFM]) connector sleeve	46 E
Z6/18	Electronics ground (HFM-SFI [HFM]) connector sleeve	54 E
Z6/30	ME-SFI [ME] diagnostic connector sleeve	49 E
Z6/30	ME-SFI [ME] diagnostic connector sleeve	56 E
Z99/6	Common rail solenoid valve 1 connector sleeve	5 E
Z99/7	Common rail solenoid valve 2 connector sleeve	11 E

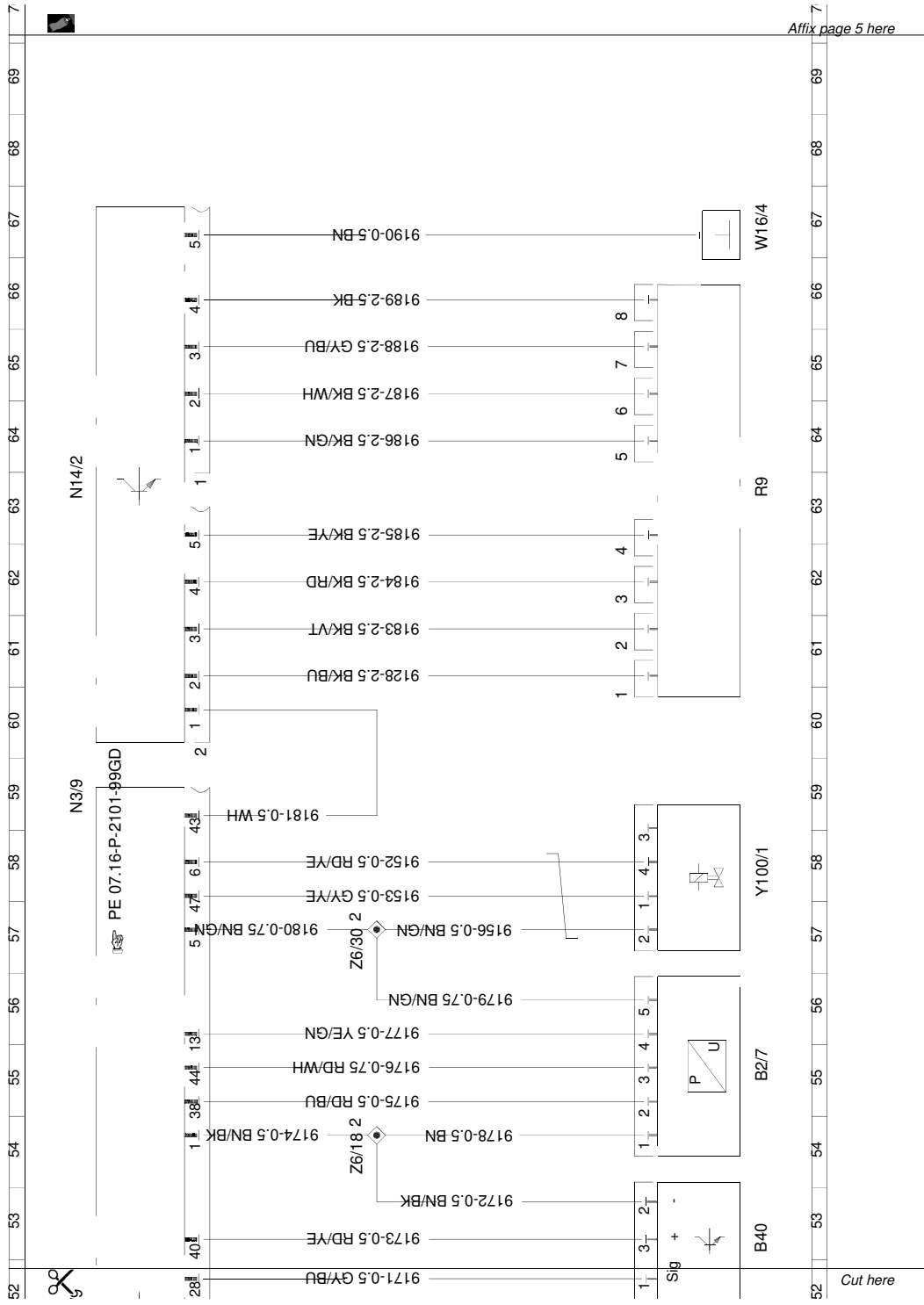

Wiring diagram for common rail diesel injection (CDI) control unit / pe07.16-p-2101-99gf
ENGINE 628.962 in MODEL 463.309 /332 /333 ## as of 1.9.03 up to 156037 Sheet 2 / Printed on: 19.08.2021 / Page 4/5

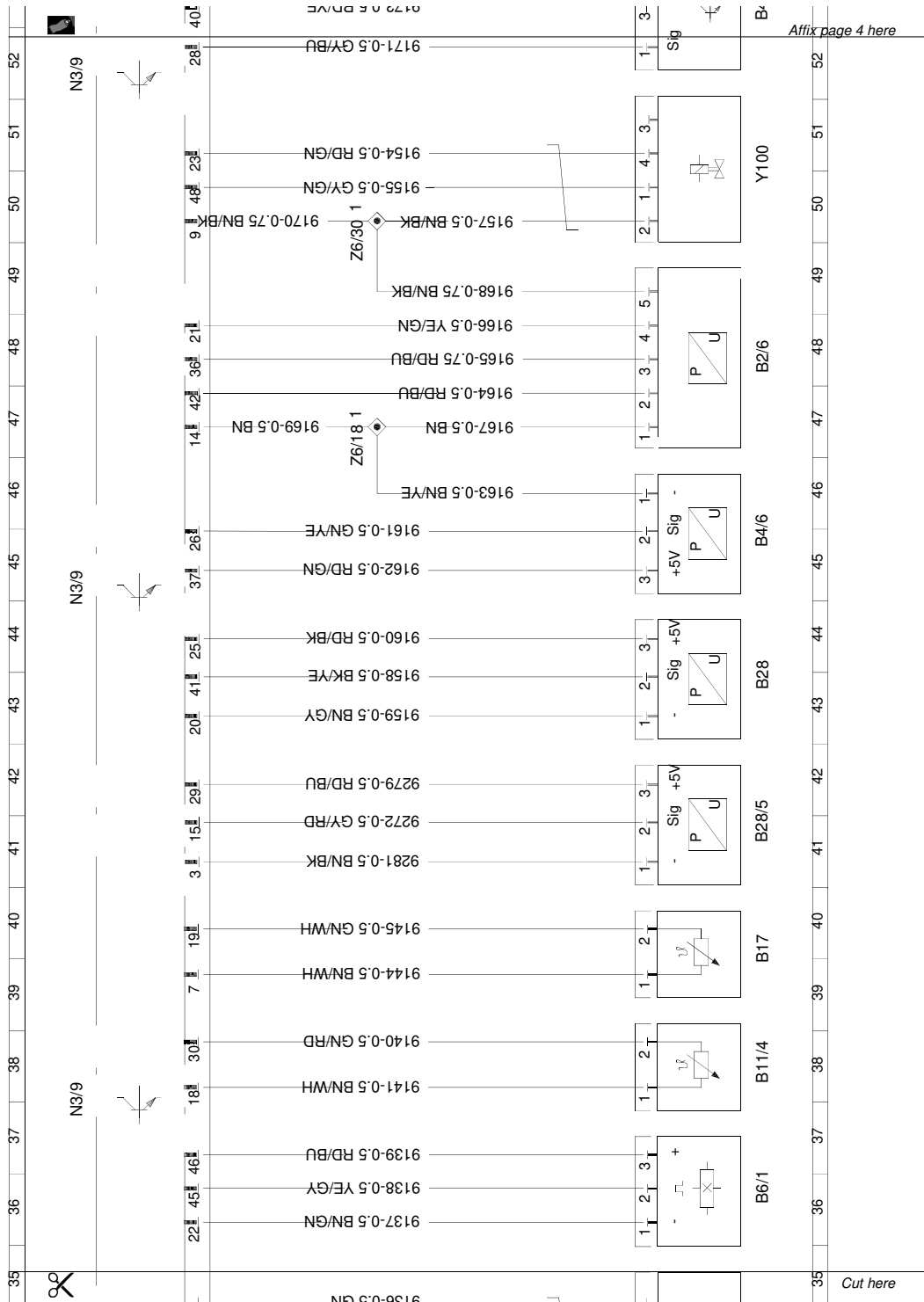

Wiring diagram for common rail diesel injection (CDI) control unit / pe07.16-p-2101-99gf
ENGINE 628.962 in MODEL 463.309 /332 /333 ## as of 1.9.03 up to 156037 Sheet 2 / Printed on: 19.08.2021 / Page 3/5

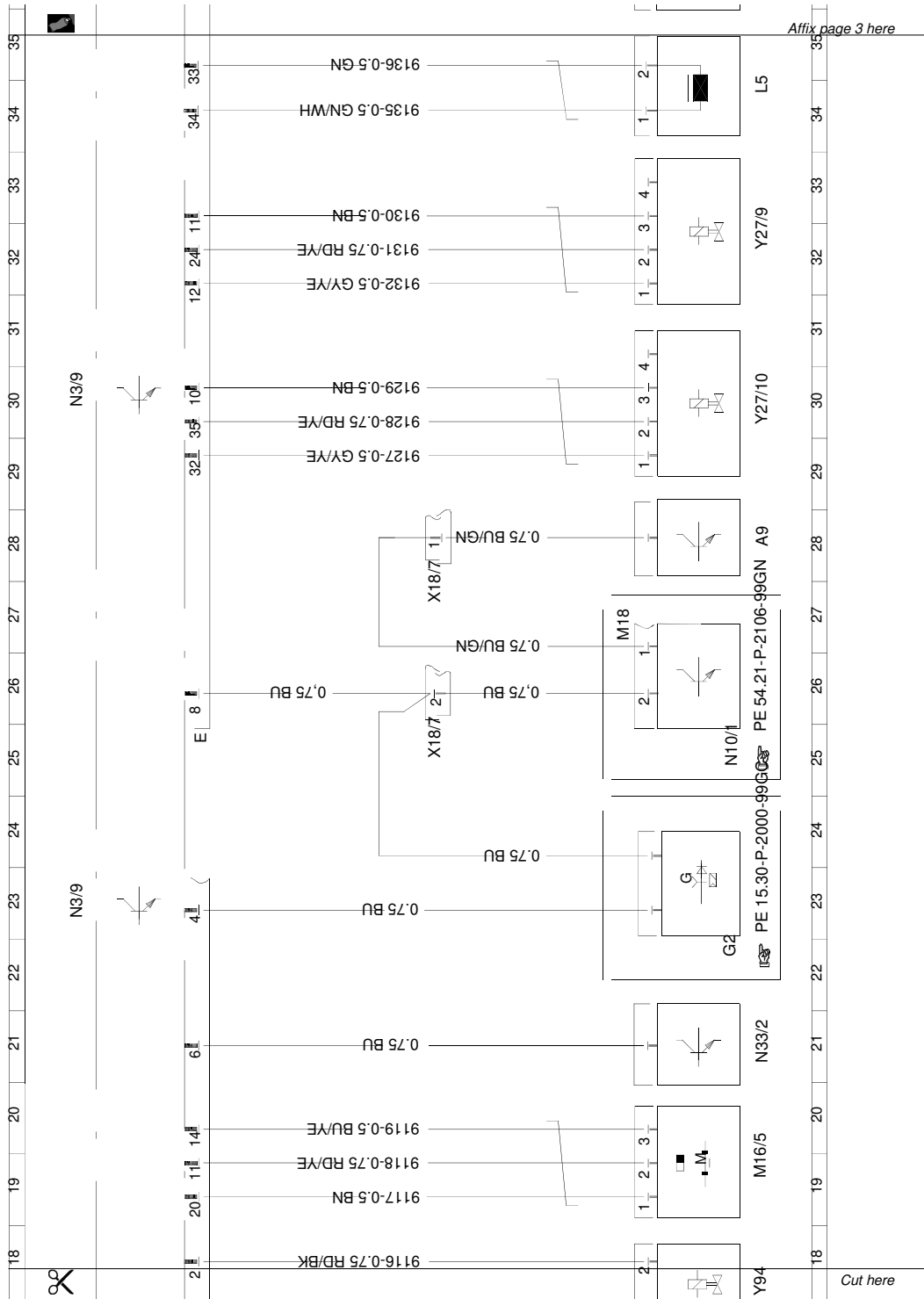

Wiring diagram for common rail diesel injection (CDI) control unit / pe07.16-p-2101-99gf
ENGINE 628.962 in MODEL 463.309 /332 /333 ## as of 1.9.03 up to 156037 Sheet 2 / Printed on: 19.08.2021 / Page 2/5

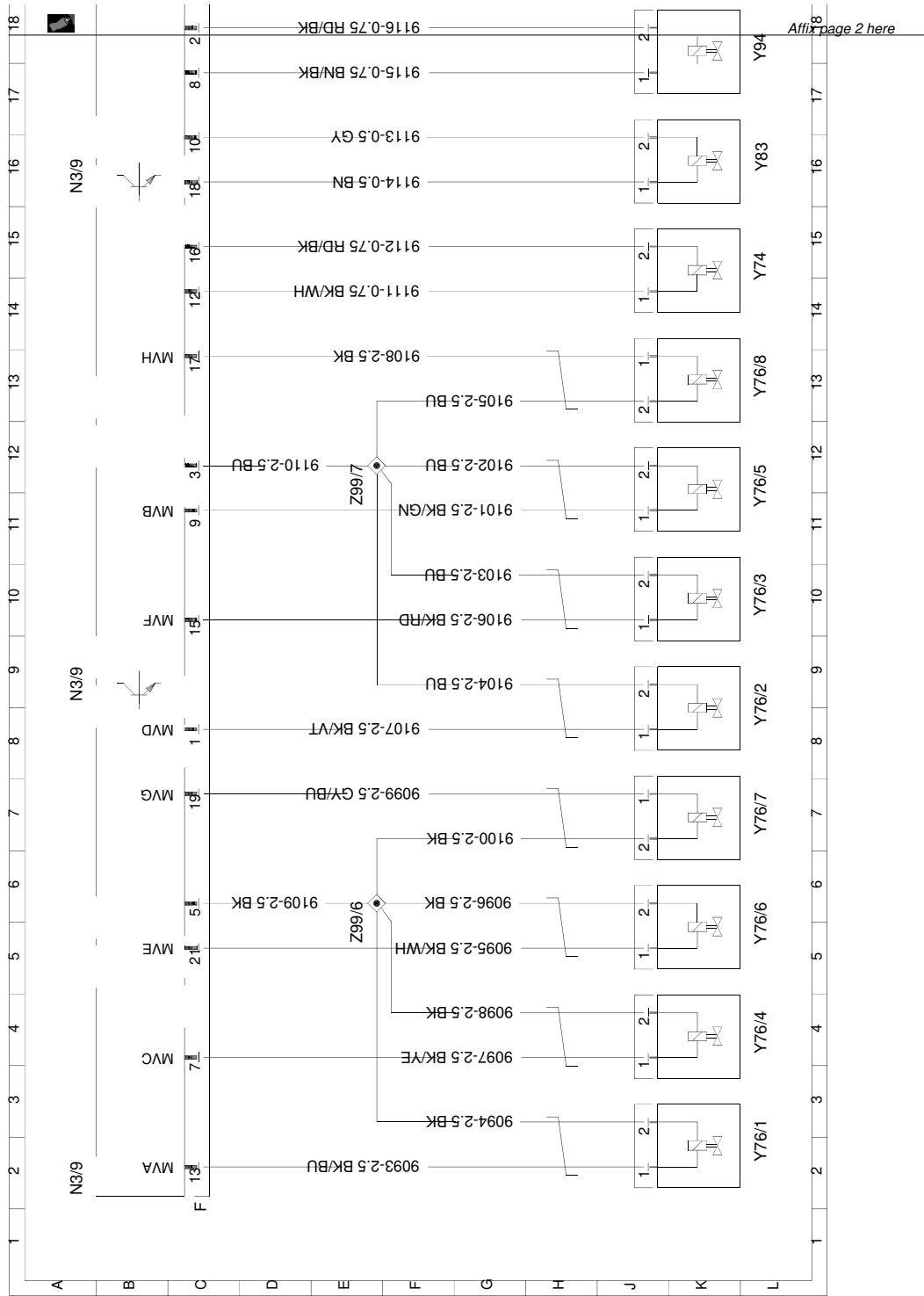

Wiring diagram for common rail diesel injection (CDI) control unit / pe07.16-p-2101-99gf
 ENGINE 628.962 in MODEL 463.309 /332 /333 ## as of 1.9.03 up to 156037 Sheet 2 / Printed on: 19.08.2021 / Page 1/5

I Toyota 1KD-FTV wiring (early)

This chapter covers the early Toyota 1KD-FTV engines as found in the Toyota J90 chassis and others that use a Denso HP2 rail pump (dual cylinder pump featuring two suction control valves).

The factory ECU uses a separate power supply (driver module) for the injectors. This module is not used and not supported by the DID1. When utilising the factory wiring it is possible to splice the feedback wire for the injector driver module to the common positive wire that goes to the injectors and splice the signal wires from the ECU to driver module to the injector wires when removing the connectors for the driver module from the harness.

The crank and cam position sensors on this engine output a low voltage so amplifier modules are required that install inside the DID1 ECU to boost those signals.

Wiring of engine devices:

Injector 1 (I10)

Device pin	Wire colour	Function	OEM pin	DID1 pin
1	blue/black	Compensation resistor	A26	No connection
2	brown	Compensation resistor ground	B20	No connection
3	red	Negative	Injector driver pin A5	5/5
4	red or green	Positive	Injector driver pin A1	5/4

Injector 2 (I11)

Device pin	Wire colour	Function	OEM pin	DID1 pin
1	blue/red	Compensation resistor	A25	No connection
2	brown	Compensation resistor ground	B20	No connection
3	red	Negative	Injector driver pin A4	5/8
4	red or green	Positive	Injector driver pin A1	5/4

Injector 3 (I12)

Device pin	Wire colour	Function	OEM pin	DID1 pin
1	blue/white	Compensation resistor	A24	No connection
2	brown	Compensation resistor ground	B20	No connection
3	red	Negative	Injector driver pin A3	5/7
4	red or green	Positive	Injector driver pin A1	5/4

Injector 4 (I13)

Device pin	Wire colour	Function	OEM pin	DID1 pin
1	red/green	Compensation resistor	A23	No connection
2	brown	Compensation resistor ground	B20	No connection
3	red	Negative	Injector driver pin A2	5/6
4	red or green	Positive	Injector driver pin A1	5/4

Rail pressure sensor (F28)

Device pin	Wire colour	Function	OEM pin	DID1 pin
1	brown	Sensor ground	B20	4/27
2	green/red	signal	B23	4/14
3	black	+5V supply	B21	4/13

Manifold absolute pressure sensor (T3)

Device pin	Wire colour	Function	OEM pin	DID1 pin
1	brown	Sensor ground	B20	4/27
2	black/yellow	signal	B16	4/6 analog in 6
3	black	+5V supply	B21	4/13

Turbocharger compensate resistor (T11)

This item is not used and not supported.

Charge air temperature sensor (I16)

Device pin	Wire colour	Function	OEM pin	DID1 pin
1	brown	Sensor ground	B20	4/27
2	blue/yellow	signal	B22	4/23 analog in 3

Fuel temperature sensor (F11)

This item is not required but can be optionally wired to analog input 10 or 11.

Engine coolant temperature sensor (W2)

Device pin	Wire colour	Function	OEM pin	DID1 pin
1	brown	Sensor ground	B20	4/27
2	green	signal	B14	4/36 analog in 2

Mass airflow meter (A13) This item is not required.

VSV Pressure Charge Valve (V15) This item is not used and must be deleted. The MAP sensor should connect directly to the intake manifold. The DID1 has an internal barometric pressure sensor so this valve is redundant.

VSV EGR Valve (V3 and V14) This item is not supported, no connection required.

Glow plug relay (Sub glow relay) In the Toyota this relay is activated by +12V supplied from the ECU. To use this with the DID1 you must either rewire the relay to be activated by a grounding output or fit an intermediate relay to convert the grounding signal to a +12V signal.

VGT turbocharger stepper motor actuator (S34)

Device pin	Wire colour	Function	OEM pin	DID1 pin
1	yellow	Winding B-	A3	3/48 Output 5
2	black/red	+12V supply	Switched 12V	3/35 or external 12V
3	yellow/green	Winding B+	A4	4/33 Output 6
4	yellow/red	Winding A-	A5	3/51 Output 7
5	black/red	+12V supply	Switched 12V	3/35 or external 12V
6	yellow/black	Winding A+	A6	3/52 Output 8

Throttle control motor (T7) This item is not supported, no connection required, deleting the valve advised.

Cruise control combo switch (C17) Connect to analog input 10 or 11.

Suction control valves (S35 and S36) These valves require current limiting. The tested configuration is to use a 4.7Ω power resistor in series with the common supply wire. This power resistor should have a power rating of 10 watts minimum (25W advised) and a small heat sink is advised. Only one resistor required for both valves as only one valve operates at any given time.

Device pin	Wire colour	Function	OEM pin	DID1 pin
SCV1 pin 1	black/yellow	SCV1 negative	A9	3/12 Output 9
SCV1 pin 2	yellow	+12V supply	A7	3/37 via 4.7Ω resistor
SCV2 pin 1	black/red	SCV2 negative	A8	3/43 Output 10
SCV2 pin 2	yellow	+12V supply	A7	3/37 via 4.7Ω resistor

Accelerator pedal position sensor (A58) This is the wiring for the Toyota pedal. There is no requirement to use a pedal specific to the engine.

Device pin	Wire colour	Function	OEM pin	DID1 pin
1	brown/white	Sensor ground	D27	3/8
2	grey	Secondary signal	D28	3/9
3	brown	Sensor ground	D24	3/23
4	green/yellow	+5V supply	D8	3/5
5	yellow/red	Primary signal	D19	3/10
6	yellow/black	+5V supply	D13	3/18

Throttle open switch (T8) This item is for diagnostics of the throttle butterfly stepper motor, which is not used.

Camshaft position sensor

Device pin	Wire colour	Function	OEM pin	DID1 pin
1	black	signal	A16	4/3
2	white	return	A27	4/2

Crankshaft position sensor

Device pin	Wire colour	Function	OEM pin	DID1 pin
1	black	signal	A17	4/26
2	white	return	A28	4/37

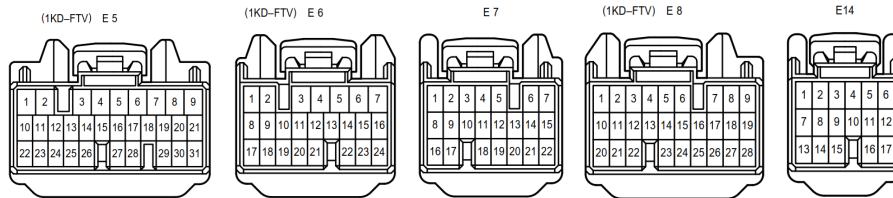
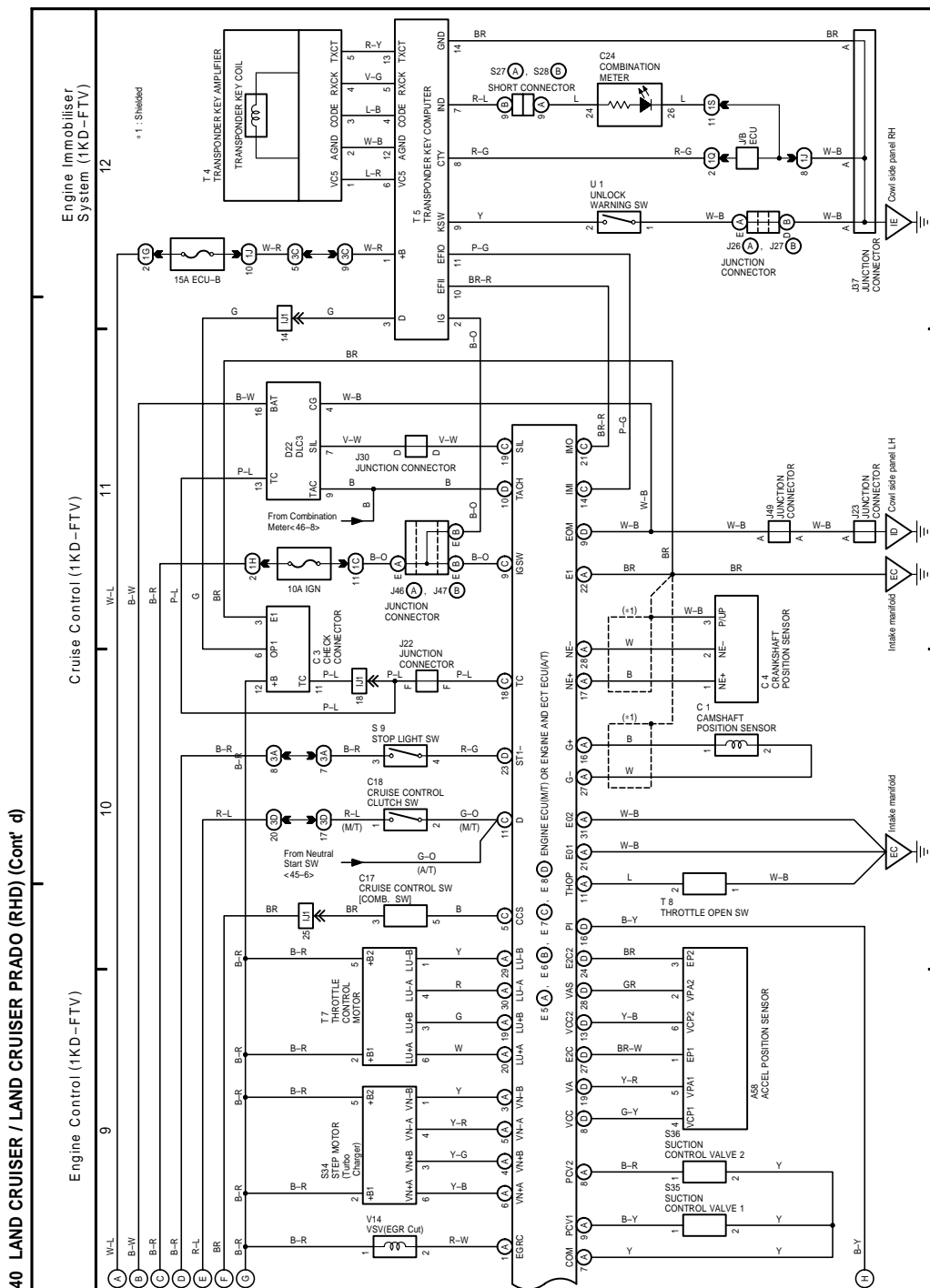
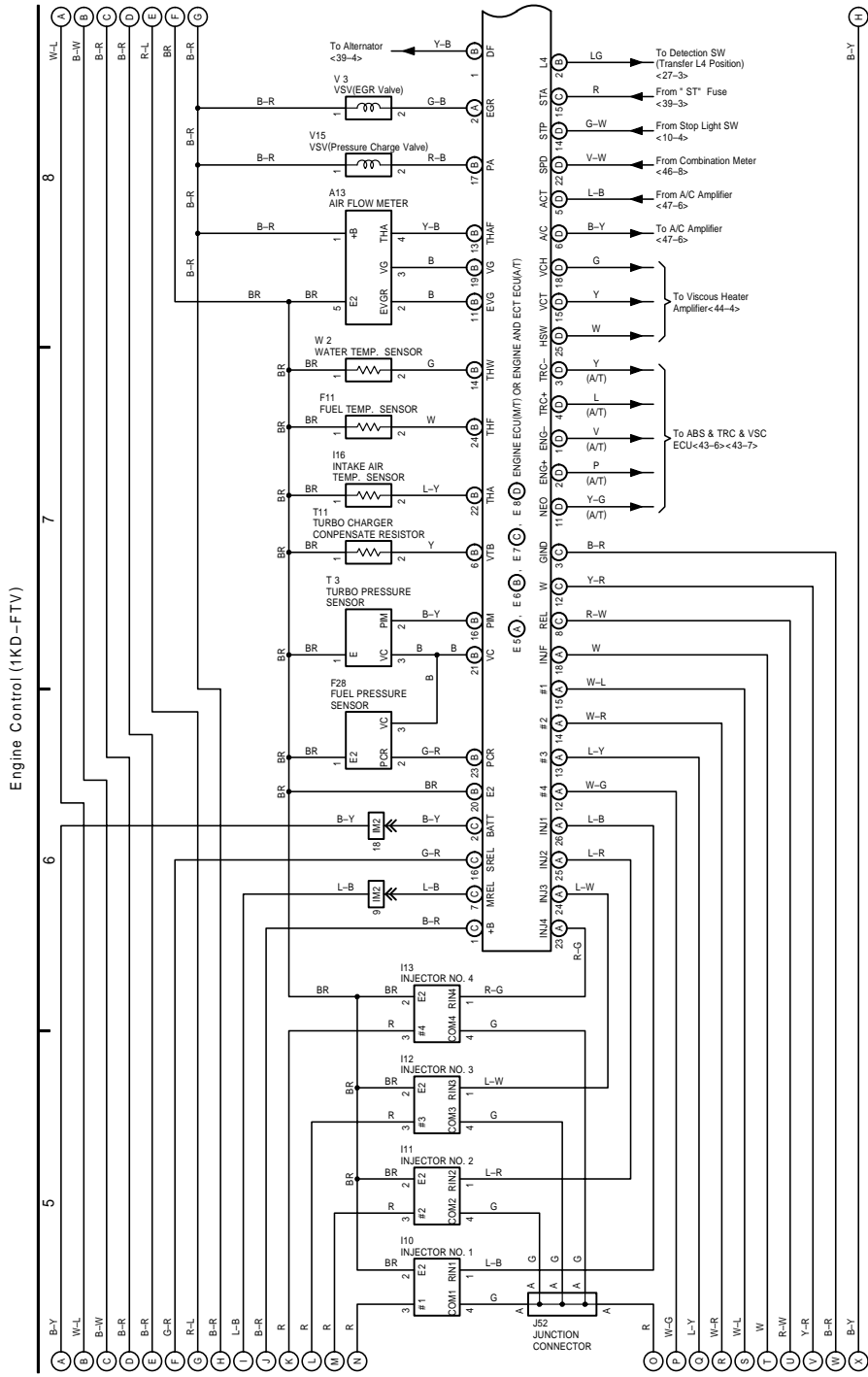

Figure I.1: Factory ECU connectors and pin numbering as seen from the ECU end of the female connectors attached to the wiring harness. In the diagrams below, E5 is referred to as A, E6 is B, E7 is C, E8 is D and E14 is not used for engine wiring at all but goes to the automatic transmission instead on cars equipped with an automatic transmission. The DID1 does not control the automatic transmission.



(Cont. next page)

40 LAND CRUISER / LAND CRUISER PRADO (RHD) (Cont' d)



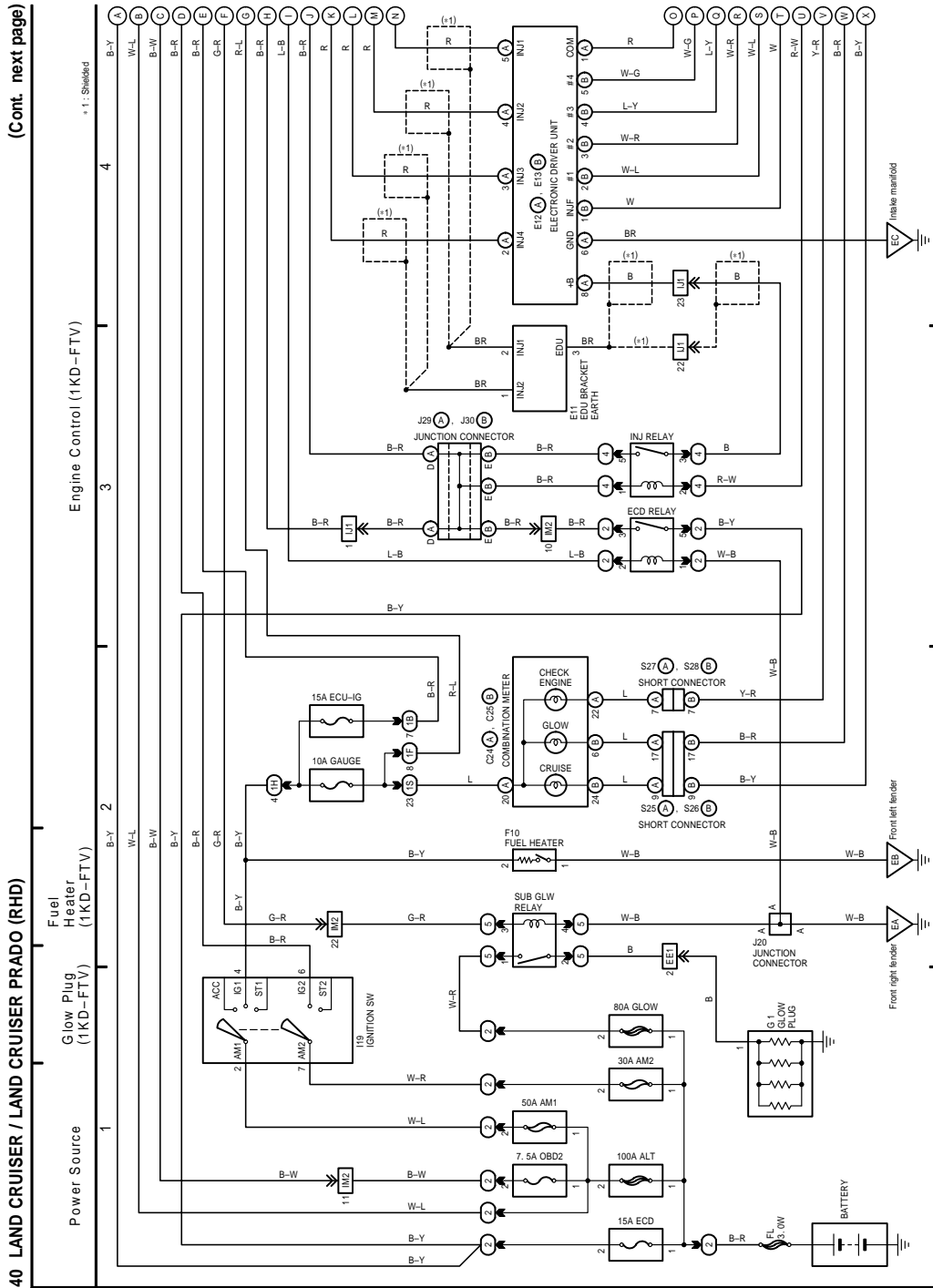

J BMW M57 wiring (E46/E39)

The first generation BMW M57 engines had ECUs similar to the Mercedes Benz OM613 engine, using the same connectors but the pinout is very different although there are shared features. Most functions are mirrored between connector 3 and connector 4 when comparing the BMW and Mercedes arrangements.

The injector loom on these engines is identical to the OM613 so they should use a DID1 ECU with plug-and-play pinout. This chapter describes wiring of these engines to the DID1 ECU, component by component.

J.1 Component wiring

Power and grounds

This is identical between the DID1 and the BMW ECU. Connector 1 pins 3, 4 and 5 are ground and pins 1, 7 and 8 are connected to switched +12V from the main relay. The BMW is a bit odd in that it provides power to pins 1 and 8, and then pin 7 is used to feed voltage back to the transmission controller, but this arrangement works fine with the DID1 also.

Main relay

The BMW controls the main relay by grounding an output on connector 1 pin 9 (brown wire). This wire should get its terminal replaced by the smaller type and inserted into connector 3/46 on the DID1.

Ignition switch

BMW provides ignition switch positive voltage to connector 4/26 (green/violet wire). This wire must be relocated to connector 3/31 or 2/13 on the DID1. (DID1 units with a serial number lower than 200 must use 2-13, 200 and up can use either)

Changeover valve for swirl flaps (B2365)

Connects to pin 3/25 on BMW ECU (brown/black wire). Usually not connected to DID1.

Changeover valve for engine mount (B2231)

Connects to pin 3/8 on BMW ECU (brown/violet wire). Usually not connected to DID1.

Changeover valve for EGR (B2244)

Connects to pin 3/10 on BMW ECU (brown/grey wire). Usually not connected to DID1.

Air mass sensor (B6217)

Not necessary, but can be connected as follows. Recommend ignoring this sensor and fit an air temperature sensor after the intercooler instead.

Device pin	Wire colour	Function	OEM pin	DID1 pin
1	blue/white	airbox temperature signal	3/29	4/23 analog in 3
2		+12V supply	in harness	
3	black	return	3/3	4/34
4	red/yellow	+5V supply	3/1	4/18
5	yellow	0-5V signal	3/2	4/24 analog in 5

Presupply pressure sensor (B2355)

A sensor monitoring feed pressure from electric lift pump, not strictly necessary but can be connected as follows:

Device pin	Wire colour	Function	OEM pin	DID1 pin
1	yellow	+5V supply	2/9	3/18
2	white/brown	return	2/10	3/19
3	black/white	0-5V signal	2/17	3/17 analog in 11

Camshaft position sensor (B6219)

Device pin	Wire colour	Function	OEM pin	DID1 pin
1	yellow	supply voltage	in harnesss	4/3
2		logic level frequency signal	3/4	
3	brown	return	3/17	4/2

Crankshaft position sensor (B2013)

Device pin	Wire colour	Function	OEM pin	DID1 pin
1	black	frequency signal	3/6	4/26
2	yellow	return	3/31	4/37
	shield	shield	3/19	4/34

Glow plug relay (K2283)

Device pin	Wire colour	Function	OEM pin	DID1 pin
6	black/yellow	feedback	3/52	n/c
11	black/red	negative switched control	3/12	4/38 output 12

MAP sensor (B2014)

Device pin	Wire colour	Function	OEM pin	DID1 pin
1	blue/yellow	0-5V signal	3/15	4/6 analog in 6
2	brown/green	return	3/16	4/7
3	white	+5V supply	3/14	4/8

Rail pressure sensor (B2261)

Device pin	Wire colour	Function	OEM pin	DID1 pin
1	brown/green	return	3/20	4/4
2	blue/black	0-5V signal	3/33	4/14 analog in 4
3	white/yellow	+5V supply	3/35	4/13

Coolant temperature sensor

Note that this appears to be a 4 pin device on these early engines, two sensor elements in one but only one sensor element connects to the engine control ECU.

Device pin	Wire colour	Function	OEM pin	DID1 pin
3	grey/blue	signal	3/28	4/36 analog in 2
4	brown/green	return	3/32	4/27

Turbocharger control solenoid (B2264)

Device pin	Wire colour	Function	OEM pin	DID1 pin
2	grey/violet	low side PWM signal	3/23	4/33 output 6

Alternator (G6524)

Not connected to the DID1 but shown here for clarity. Pin 1 is a blue wire that connects to BMW ECU pin 3/50, its function is a charge indicator lamp. Must connect to a charge indicator lamp to enable normal charging. Bridge to the blue wire going to pin 4/1 on BMW ECU if using BMW wiring harness, this wire goes to the instrument cluster.

Pin 2 is a blue/green wire that connects to BMW ECU pin 3/24, its function is an alternator load signal and no connection is required.

Rail pressure control valve (B2262)

Device pin	Wire colour	Function	OEM pin	DID1 pin
2	brown/blue	low side PWM signal	3/38	4/21 output 3

Oil level sensor (B6254)

This is a grey/brown wire going to pin 3/40 on the BMW ECU. Bridge to white/green wire on pin 4/21 or maybe connect to ECU. To be tested.

Device pin	Wire colour	Function	OEM pin	DID1 pin
3	grey/brown	pulse width coded signal	3/40	4/15 digital in 6

Oil pressure switch (B2008)

This is a brown/green wire going to pin 3/41 on the BMW ECU.
 Bridge to brown/green wire on pin 4/11. No connection to DID1
 necessary.

Electric fan (M9)

Device pin	Wire colour	Function	OEM pin	DID1 pin
2	black/green	low side PWM signal	4/4	3/52 output 8

Pedal position sensor (R10)

Device pin	Wire colour	Function	OEM pin	DID1 pin
1	brown/green	return	4/7	3/8
2	brown	return	4/12	3/23
3	yellow/white or yellow/green	+5V supply	4/14	3/5
4	white	primary signal	4/8	3/10 analog in 0
5	yellow	+5V supply	4/9	3/18
6	grey/yellow or white/green	secondary signal	4/13	3/9 analog in 1

Lift pump relay (K96)

Device pin	Wire colour	Function	OEM pin	DID1 pin
4	black/violet	low side switching signal	4/10	3/12 output 9

J.2 Original ECU pinout

Connector location views

Number	X-pin, colour	Description
X2411	9-pin, black	Plug connector Digital diesel electronics control unit Module 1
X2412	24-pin, black	Plug connector Digital diesel electronics control unit Module 2
X2413	52-pin, black	Plug connector Digital diesel electronics control unit Module 3
X2414	40-pin, black	Plug connector Digital diesel electronics control unit Module 4
X2415	9-pin, black	Plug connector Digital diesel electronics control unit Module 5

Pin assignments at plug connector X2411

Pin	Type	Description /Signal type	Connection /Measuring notes
1	E	Voltage supply Terminal 15	Fuse carrier, engine electronics
2		Not used	
3	E/A	Diagnostic link TXD	Transmission control unit
4	M	Signal, lock front passenger's door	Ground connector
5	M	Signal, lock front passenger's door	Ground connector
6	M	Signal, lock front passenger's door	Ground connector
7	A	Terminal 15	Transmission control unit
8	E	Voltage supply Terminal 15	Fuse carrier, engine electronics
9	E	Activation, main relay	DDE relay

Pin assignments at plug connector X2412

Pin	Type	Description /Signal type	Connection /Measuring notes
1		Not used	
2		Not used	
3	E/A	CAN bus low	Transmission control unit
4	E/A	CAN bus high	Transmission control unit
5		Not used	
6		Not used	
7		Not used	
8	A	Activation, engine mount	Electrical changeover valve, engine mount
9	A	Supply Presupply pressure sensor	Presupply pressure sensor
10	M	Ground Presupply pressure sensor	Presupply pressure sensor
11		Not used	
12		Not used	
13		Not used	
14		Not used	
15		Not used	
16		Not used	
17	E	Signal Presupply pressure sensor	Presupply pressure sensor
18		Not used	
19		Not used	
20		Not used	
21		Not used	
22		Not used	
23		Not used	
24		Not used	

Pin assignments at plug connector X2413

Pin	Type	Description /Signal type	Connection /Measuring notes
1	A	Supply Air mass sensor	Air mass sensor
2	E	Signal Air mass sensor	Air mass sensor
3	M	Ground Air mass sensor	Air mass sensor
4	E	Signal Hall-effect sensor, camshaft 1	Hall-effect sensor, camshaft 1
5		Not used	
6	E	Signal Speed (rpm) sensor	Speed (rpm) sensor
7		Not used	
8		Not used	
9		Not used	

10	E	Signal Solenoid valve, exhaust gas recirculation	Solenoid valve, exhaust gas recirculation
11		Not used	
12	E	Signal Preheater relay	Preheater relay
13		Not used	
14	A	Supply Boost pressure sensor	Boost pressure sensor
15	E	Signal Boost pressure sensor	Boost pressure sensor
16	M	Ground Boost pressure sensor	Boost pressure sensor
17	M	Ground Hall-effect sensor, camshaft 1	Hall-effect sensor, camshaft 1
18		Not used	
19	M	Shield, speed (rpm) sensor	Speed (rpm) sensor
20	M	Ground Rail pressure sensor	Rail pressure sensor
21		Not used	
22		Not used	
23	A	Supply Solenoid valve, supercharger control	Solenoid valve, supercharger control
24	E	Alternator load signal	Alternator
25	A	Signal Electric changeover valve, swirl flaps	Electric changeover valve, swirl flaps
26		Not used	
27		Not used	
28	E	Signal Coolant temperature sensor	Coolant temperature sensor
29	E	Signal Intake air temperature	Air mass sensor
30		Not used	
31	M	Ground Speed (rpm) sensor	Speed (rpm) sensor
32	M	Ground Coolant temperature sensor	Coolant temperature sensor
33	E	Signal Rail pressure sensor	Rail pressure sensor
34		Not used	
35	A	Supply Rail pressure sensor	Rail pressure sensor
36		Not used	
37		Not used	
38	A	Supply Rail pressure control valve	Rail pressure control valve
39		Not used	
40	E	Signal Oil level sensor	Oil level sensor
41	E	Signal Oil pressure switch	Oil pressure switch
42		Not used	
43		Not used	
44		Not used	
45		Not used	
46		Not used	
47		Not used	
48		Not used	
49		Not used	
50	E	Signal Battery charge indicator lamp	Alternator
51	E	Voltage signal, terminal 30h	Starter
52	E	Signal Preheater relay	Preheater relay

Pin assignments at plug connector X2414

Pin	Type	Description /Signal type	Connection /Measuring notes
1	A	Battery charge indicator lamp signal (terminal 61)	Instrument cluster control unit
2	A	Voltage signal, terminal 30h	Instrument cluster control unit
3		Not used	
4	E	Signal Electric fan	Electric fan
5		Not used	
6		Not used	
7	M	Ground Pedal position sensor	Pedal position sensor
8	E	Signal Pedal position sensor	Pedal position sensor
9	A	Supply Pedal position sensor	Pedal position sensor
10	E	Signal Fuel pump relay 1	Fuel pump relay 1
11	A	Signal Oil pressure indicator lamp	Instrument cluster control unit
12	M	Ground Pedal position sensor	Pedal position sensor

13	E	Signal Pedal position sensor	Pedal position sensor
14	A	Supply Pedal position sensor	Pedal position sensor
15		Not used	
16		Not used	
17	A	Engine speed signal output (TD)	Diagnostic connector
18		Not used	
19		Not used	
20	A	Activation Auxiliary heater	Auxiliary heater
21	A	Signal Oil level sensor	Light switching centre control unit
22	E	Rear right speed signal	ABS/ASC unit ABS/DSC unit
23	E	Signal Clutch switch	Clutch switch
24	E	Signal Brake light switch	Brake light switch
25		Not used	
26	A	Voltage supply Terminal 15	Fuse F29
27	E	Data link MFL	Volute spring
28	E	Brake light test signal	Brake light switch
29	E	A/C compressor signal	Relay, A/C compressor
30		Not used	
31	E	Signal Auxiliary heater	Heating and A/C control module
32	E/A	Signal Diagnostic link TXD	Diagnostic connector
33	E/A	Communication line (EWS)	Electronic immobiliser control unit
34		Not used	
35		Not used	
36	E/A	CAN bus high	Connector, CAN bus
37	E/A	CAN bus low	Connector, CAN bus
38	M	Ground Coolant outlet temperature sensor	Coolant outlet temperature sensor
39	E	Signal Coolant outlet temperature sensor	Coolant outlet temperature sensor
40		Not used	

Pin assignments at plug connector X2415

Pin	Type	Description /Signal type	Connection /Measuring notes
1	A	Supply, injectors 4-6	U422 Voice input
2		Not used	
3	A	Signal, injector 6	Injector 6
4	A	Supply, injectors 1-3	U407 Basic interface telephone
5	A	Signal, injector 1	Injector 1
6	A	Signal, injector 4	Injector 4
7	A	Signal, injector 3	Injector 3
8	A	Signal, injector 2	Injector 2
9	A	Signal, injector 5	Injector 5

K Ssangyong D27DT (OM665) wiring

This is for the first generation of the D27DT engine, contact support for information on the later generation D27DTP.

K.1 Component wiring

Wastegate valve

Device pin	Wire colour	Function	OEM pin	DID1 pin
1	yellow/red	+12V	Fuse Ef6	
2	black/green	PWM control	95	4/33 Output 6

Inlet metering valve valve

This valve is located at the back of the high pressure fuel pump and regulates the rail pressure

Device pin	Wire colour	Function	OEM pin	DID1 pin
1	green/yellow	+12V	Fuse Ef5	
2	black/red	PWM control	87	4/21 Output 3

Preheating unit

Not shown are the glow plug, ground and battery connections.

Device pin	Wire colour	Function	OEM pin	DID1 pin
2	lightgreen	K-line	34	not used
4	red/green	relay control	113	3/43 Output 10

Fuel pressure sensor (rail pressure)

First colour listed is at sensor end, if there's a second colour the wire changes colour going through connector C115 in the original harness.

Device pin	Wire colour	Function	OEM pin	DID1 pin
1	green/white	Signal	25	4/14 Analog 4
2	black & red/green	return	26	4/4
3	green & black/green	+5V supply	6	4/13

Camshaft sensor

Hall effect type sensor.

Device pin	Wire colour	Function	OEM pin	DID1 pin
1	blue	+5V supply	111	4/12
2	white/black & grey	signal	103	4/3
3	yellow & grey/black	return	6	4/2

Boost pressure (MAP) sensor

Device pin	Wire colour	Function	OEM pin	DID1 pin
1	grey/yellow & grey/green blue & yellow/red	signal	99	4/6
2		+5V supply	108	4/8
4	red/green & blue/white	return	100	4/7

Crankshaft sensor

Variable reluctance sensor.

Device pin	Wire colour	Function	OEM pin	DID1 pin
1	white/red & green	signal	90	4/26
2	blue & green/white	return	82	4/37

Coolant temperature sensor

Device pin	Wire colour	Function	OEM pin	DID1 pin
1	yellow/green & blue/yellow	signal	101	4/36
4	yellow/grey & red	return	102	4/27

Knock sensor #1 and #2

No connection. Not used.

Fuel temp sensor

No connection. Not used.

Exhaust gas pressure sensor

No connection. Not used.

Injector 1

Device pin	Wire colour	Function	OEM pin	DID1 pin
2	blue	control	114	5/5
1	red	supply	117	5/4

Injector 2

Device pin	Wire colour	Function	OEM pin	DID1 pin
1	red/white	supply	118	5/4
2	green/black	control	121	5/8

Injector 3

Device pin	Wire colour	Function	OEM pin	DID1 pin
1	red	supply	117	5/4
2	yellow	control	116	5/7

Injector 4

Device pin	Wire colour	Function	OEM pin	DID1 pin
1	red	supply	117	5/4
2	green	control	115	5/6

Injector 5

Device pin	Wire colour	Function	OEM pin	DID1 pin
1	red/white	supply	118	5/4
2	blue/black	control	120	5/9

K.2 Factory wiring diagrams

(1) CONNECTOR INFORMATION

Connector Number (Pin Number, Color)	Connecting Wiring Harness	Connector Position	Remark
C102 (20Pin, White)	W/H Floor - Eng Room Fuse & Relay Box	Eng Room Fuse & Relay Box	
C104 (20Pin, White)	W/H Floor - Eng Room Fuse & Relay Box	Eng Room Fuse & Relay Box	
C105 (22Pin, White)	W/H Floor - Eng Room Fuse & Relay Box	Eng Room Fuse & Relay Box	
C106 (18Pin, White)	W/H Floor - Eng Room Fuse & Relay Box	Eng Room Fuse & Relay Box	
C108 (4Pin, Cobaltless)	W/H Eng - Eng Room Fuse & Relay Box	Eng Room Fuse & Relay Box	
C109 (18Pin, White)	W/H Eng - Eng Room Fuse & Relay Box	Eng Room Fuse & Relay Box	
C115 (42Pin, Black)	W/H Floor - W/H Eng Control	Right Eng Room Dash PNL	
C207 (38Pin, Gray)	W/H Main - W/H Floor	Driver Cowl Side C/Holder	C/Holder
C209 (28Pin, Black)	W/H Main - W/H Floor	Driver Cowl Side C/Holder	C/Holder
C216 (28Pin, White)	W/H Main - W/H Eng	Passenger Cowl Side C/Holder	C/Holder
G201 (18Pin, White)	W/H Main - W/H Eng	Under the Driver Cowl Side PNL	
S201 (14Pin, Black)	W/H Main	Upper the I/P Relay Box	
S205 (14Pin, Black)	W/H Main	Backside A/V Head Unit	

(2) CONNECTOR IDENTIFICATION SYMBOL & PIN NUMBER POSITION

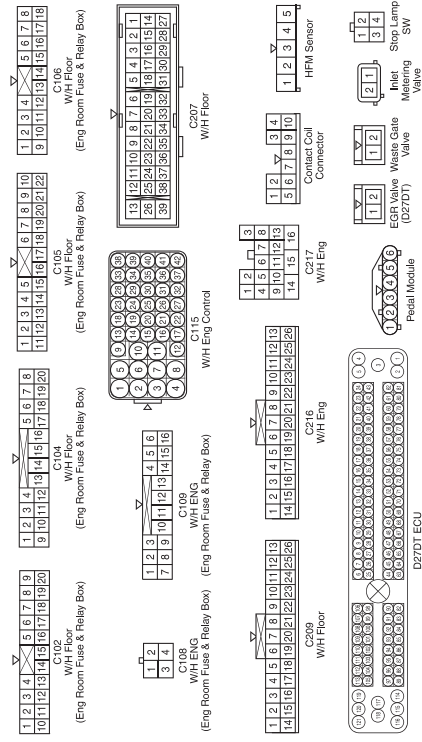

1491-01 ECU (ENGINE CONTROL UNIT - D27DT)

1) ENG MAIN RELAY, PEDAL MODULE, HFM SENSOR, VALVE, CRUISE CONTROL SW

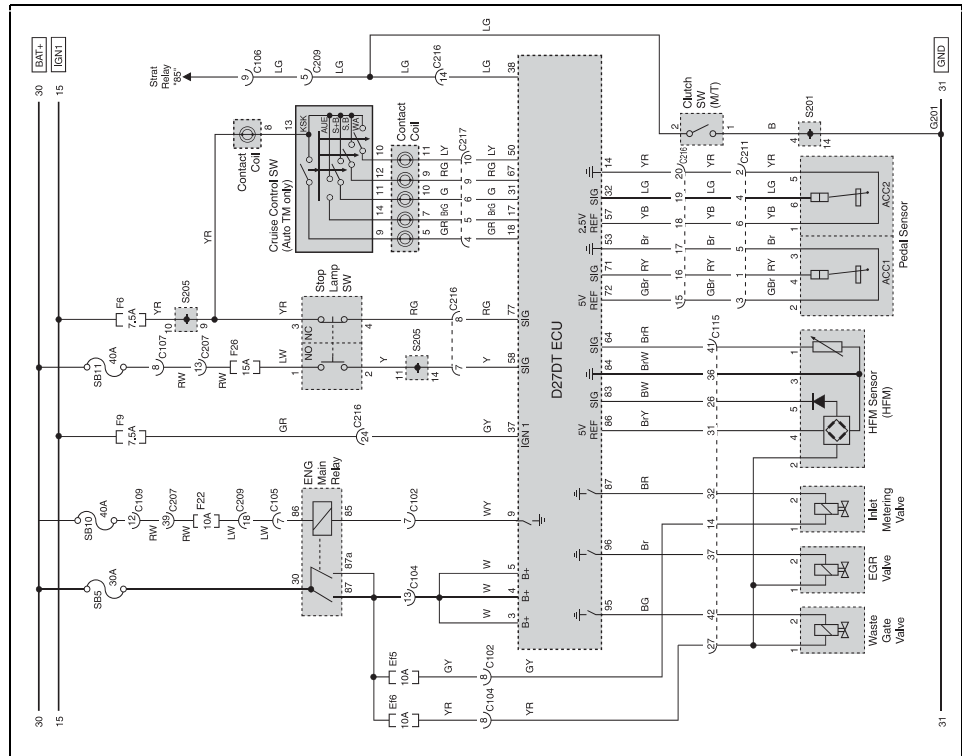

Modification basis	
Application basis	
Affected VIN	

2) FUEL FILTER WARNING LAMP, IMMOBILIZER, SENSOR (FUEL PRESSURE, CAMSHAFT, BOOSTER PRESSURE, RANKSHAFT, KNOCK, COOLANT/FUEL TEMP.)

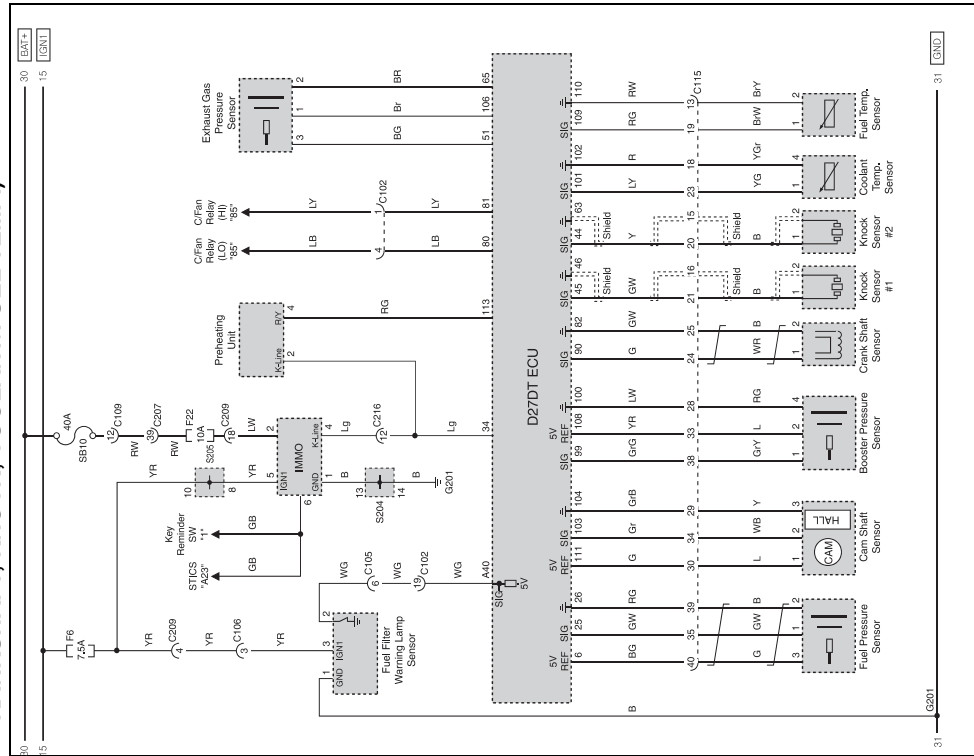

(1) CONNECTOR INFORMATION

Connector Number (Pin Number, Color)	Connecting Wiring Harness	Connector Position	Remark
C102 (20Pin, White)	W/H Floor - Eng Room Fuse & Relay Box	Eng Room Fuse & Relay Box	
C105 (22Pin, White)	W/H Floor - Eng Room Fuse & Relay Box	Eng Room Fuse & Relay Box	
C106 (18Pin, White)	W/H Floor - Eng Room Fuse & Relay Box	Eng Room Fuse & Relay Box	
C110 (4Pin, White)	W/H Eng - Eng Room Fuse & Relay Box	Eng Room Fuse & Relay Box	
C115 (42Pin, Black)	W/H Floor - W/H Eng Control	Right Eng Room Dash PNL	PTC
C202 (4Pin, White)	W/H Main - W/H Floor	Under the I/P Fuse Box	
C209 (26Pin, Black)	W/H Main - W/H Floor	Driver Cowl Side C/Holder	C/Holder
C216 (26Pin, White)	W/H Main - W/H Eng	Passenger Cowl Side C/Holder	C/Holder
C217 (16Pin, White)	W/H Main - W/H Eng	Passenger Cowl Side C/Holder	C/Holder
G201	W/H Main	Under the Driver Cowl Side PNL	
S204 (14Pin, Black)	W/H Main	Backside A/V Head Unit	
S205 (14Pin, Black)	W/H Main	Backside A/V Head Unit	

(2) CONNECTOR IDENTIFICATION SYMBOL & PIN NUMBER POSITION

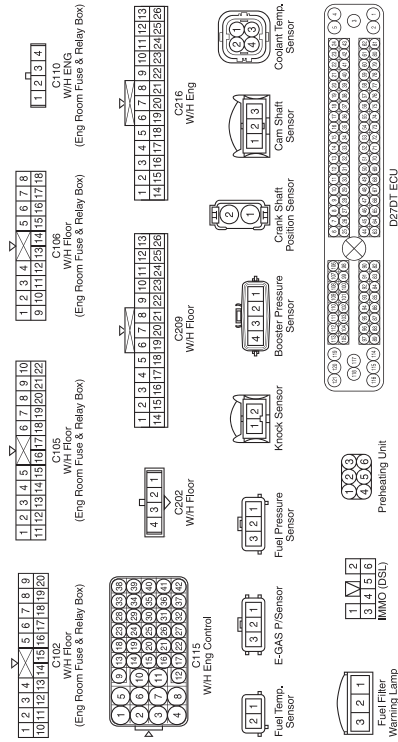

Modification basis
Application basis
Affected VIN

(1) CONNECTOR INFORMATION

Connector Number (Pin Number, Color)	Connecting Wiring Harness	Connector Position	Remark
C102 (20Pin, White)	W/H Floor - Eng Room Fuse & Relay Box	Eng. Room Fuse & Relay Box	
C115 (42Pin, Black)	W/H Floor - W/H Eng Control	Right Eng Room Dash PNL	
C209 (26Pin, Black)	W/H Main - W/H Floor	Driver Cowl Side C/Holder	C/Holder
C213 (16Pin, White)	W/H Main - W/H A/Con	Backside the AV Head Unit	
C216 (26Pin, White)	W/H Main - W/H Eng	Passenger Cowl Side C/Holder	C/Holder
C217 (16Pin, White)	W/H Main - W/H Eng	Passenger Cowl Side C/Holder	C/Holder
G205	W/H Main	Beside Eng ECU (GSU)	
S203 (14Pin, Black)	W/H Main	Upper the I/P Relay Box	CAN
S301 (14Pin, Black)	W/H Floor	Under the Driver Seat	CAN

(2) CONNECTOR IDENTIFICATION SYMBOL & PIN NUMBER POSITION

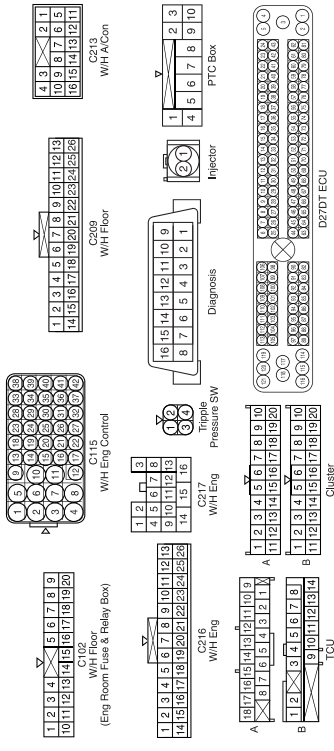

3) INJECTOR, CAN LINE

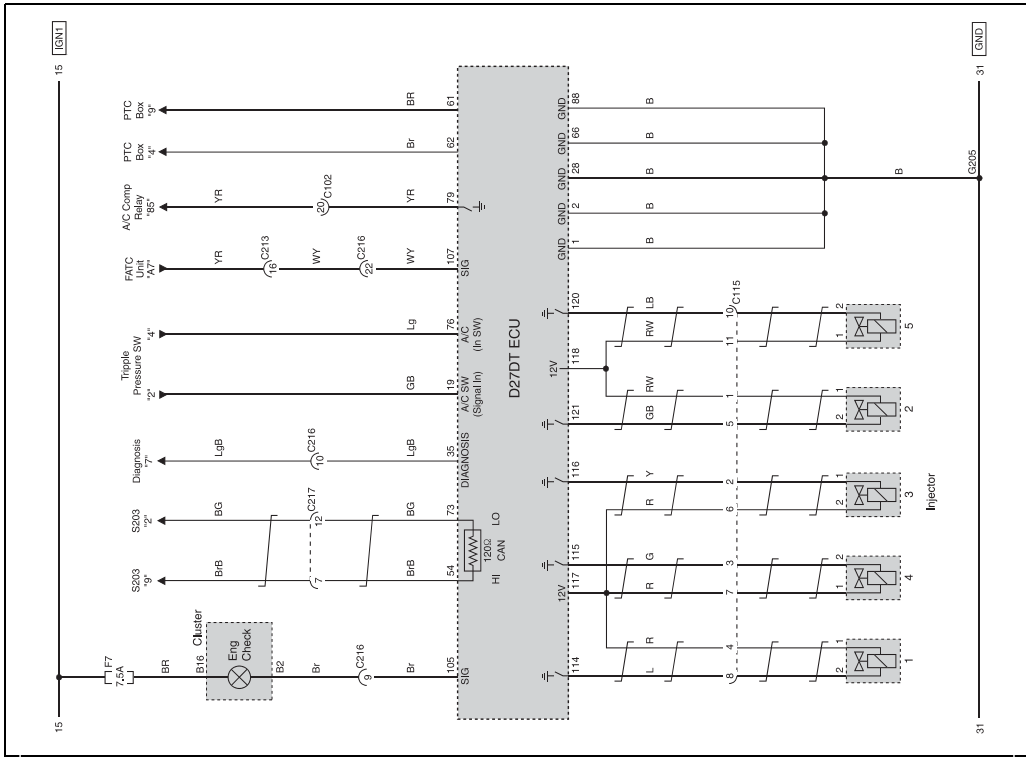

Modification basis	
Application basis	
Affected VIN	

L Mercedes Benz Sprinter 906 wiring

Due to the variety of undersized overworked engines offered in this series of light transporters, engine swaps are popular. This chapter explains adapting the chassis side wiring to the DID1 for a car that comes with the OM646 twin turbo engine.

Power supply

Colour	Function	OEM pin	DID1 pin
black/green	ECU +12V	F5	1/7
black/grey	Peripheral +12V	F3	1/1
black	Ignition switch circuit 15	F41	3/31
black/white	Main relay control	F42	3/46
red/black	Starter control	F44	3/43 output 10
red/white	Fuel lift pump control	F32	3/12 output 9
brown	Power ground	F2	1/4
brown	Power ground	F4	1/5
brown	Power ground	F6	1/6

Accelerator pedal (B37/3)

Device pin	Wire colour	Function	OEM pin	DID1 pin
1	red/yellow	primary +5V	F15	3/5
2	yellow	primary signal	F24	3/10
3	brown/yellow	primary return	F7	3/8
4	brown/white	secondary return	F40	3/23
5	pink/violet	secondary +5V	F17	3/18
6	white	secondary signal	F12	3/9